



# Service Manual

Models: GTH(09)CA-K6DNA1A/I  
GTH(12)CA-K6DNA1A/I  
GTH(18)CA-K6DNA1A/I  
GTH(24)CB-K6DNA2A/I  
(Refrigerant R32)

Gree Climat

**GREE ELECTRIC APPLIANCES, INC. OF ZHUHAI**

## Table of Contents

<b>Part I : Technical Information</b> .....	1
<b>1. Summary</b> .....	1
<b>2. Specifications</b> .....	2
<b>3. Outline Dimension Diagram</b> .....	5
<b>4. Refrigerant System Diagram</b> .....	6
<b>5. Electrical Part</b> .....	7
5.1 Wiring Diagram.....	7
5.2 PCB Printed Diagram.....	8
<b>6. Function and Control</b> .....	9
6.1 Remote Controller Introduction.....	9
6.2 Brief Description of Modes and Functions.....	13
<b>Part II : Installation and Maintenance</b> .....	16
<b>7. Indoor Unit Installation</b> .....	16
<b>8. Maintenance</b> .....	26
<b>9. Exploded View and Parts List</b> .....	34
<b>10. Removal Procedure</b> .....	37



## 2. Specifications

### 2.1 Specification Sheet

Parameter		Unit	Value	
Model			GTH(09)CA-K6DNA1A/I	GTH(12)CA-K6DNA1A/I
Product Code			CN610N0130	CN610N0140
Power Supply	Rated Voltage	V~	220-240	220-240
	Rated Frequency	Hz	50	50
	Phases		1	1
Cooling Capacity		W	2600	3500
Heating Capacity		W	2700	4000
Cooling Power Input		W	40	40
Heating Power Input		W	40	40
Cooling Current Input		A	0.17	0.17
Heating Current Input		A	0.17	0.17
Air flow volume(SH/H/M/L/SL)		m <sup>3</sup> /h	700/610/540/420/-	700/610/540/420/-
Dehumidifying Volume		L/h	0.8	1.4
Fan Type			Centrifugal	Centrifugal
Fan Diameter-height		mm	Φ155-185	Φ155-185
Fan Motor Speed		rpm	790/690/610/480	790/690/610/480
Fan Motor Power Output		W	15	15
Fan Motor Power Input		W	38	38
Motor Full Load Amp(FLA)		A	0.28	0.28
Fan Motor Capacitor		μF	1	1
Evaporator Material			Aluminum fin-copper tube	Aluminum fin-copper tube
Evaporator Pipe Diameter		mm	Φ5	Φ5
Evaporator Number of Rows-Fin Pitch		mm	2-1.3	2-1.3
Evaporator Length(L)XHeight(H)XWidth(W)		mm	577X304X22.8	577X304X22.8
Fuse Current		A	5	5
Sound Pressure Level(SH/H/M/L/SL)		dB (A)	38/35/30/26/-	38/35/30/26/-
Sound Power Level(SH/H/M/L/SL)		dB (A)	52/49/44/40/-	52/49/44/40/-
Dimension of Outline(LXWXH)		mm	870X235X665	870X235X665
Dimension of Carton Box(LXWXH)		mm	1030X767X285	1030X767X285
Dimension of Package(LXWXH)		mm	1033X770X300	1033X770X300
Net Weight		kg	25	25
Gross Weight		kg	30	30
Liquid pipe		mm	Φ6	Φ6
Gas Pipe(to indoor unit)		mm	Φ9.52	Φ12

The above data is subject to change without notice. Please refer to the nameplate of the unit.

Parameter	Unit	Value	
Model		GTH(18)CA-K6DNA1A/I	GTH(24)CB-K6DNA2A/I
Product Code		CN610N0150	CN610N0160
Power Supply	Rated Voltage	V~	220-240
	Rated Frequency	Hz	50
	Phases		1
Cooling Capacity	W	4500	7100
Heating Capacity	W	5000	8000
Cooling Power Input	W	40	60
Heating Power Input	W	40	60
Cooling Current Input	A	0.17	0.26
Heating Current Input	A	0.17	0.26
Air flow volume(SH/H/M/L/SL)	m <sup>3</sup> /h	680/590/520/410/-	950/870/800/720/-
Dehumidifying Volume	L/h	1.8	2.5
Fan Type		Centrifugal	Centrifugal
Fan Diameter-height	mm	Φ155-185	Φ155-185
Fan Motor Speed	rpm	790/690/610/480	760/700/640/580
Fan Motor Power Output	W	15	20
Fan Motor Power Input	W	38	60
Motor Full Load Amp(FLA)	A	0.28	0.3
Fan Motor Capacitor	μF	1	2
Evaporator Material		Aluminum fin-copper tube	Aluminum fin-copper tube
Evaporator Pipe Diameter	mm	Φ5	Φ5
Evaporator Number of Rows-Fin Pitch	mm	3-1.4	3-1.4
Evaporator Length(L)XHeight(H)XWidth(W)	mm	577X304X34.2	905X304X34.2
Fuse Current	A	5	5
Sound Pressure Level(SH/H/M/L/SL)	dB (A)	38/35/30/26/-	38/35/30/26/-
Sound Power Level(SH/H/M/L/SL)	dB (A)	52/49/44/40/-	52/49/44/41/-
Dimension of Outline(LXWXH)	mm	870X235X665	1200X235X665
Dimension of Carton Box(LXWXH)	mm	1030X767X285	1360X767X285
Dimension of Package(LXWXH)	mm	1033X770X300	1363X770X300
Net Weight	kg	25.5	33
Gross Weight	kg	30.5	40
Liquid pipe	mm	Φ6	Φ9.52
Gas Pipe(to indoor unit)	mm	Φ12	Φ16

The above data is subject to change without notice. Please refer to the nameplate of the unit.

Note: Nominal capacities are based on the follow conditions.

Mode		Indoor °C(°F)	Outdoor °C(°F)
Cooling		DB:27 (80.6)	DB:35(95)
		WB:19 (66.2)	WB:24(75.2)
Heating		DB:20 (68)	DB:7(44.6)
		WB:--(--)	WB:6 (42.8)
Piping Length	Duct type, Cassette type\ Floor ceiling type	5m	

The air volume is measured at the relevant standard external static pressure.

Noise is tested in the semianechoic room, so it should be slightly higher in the actual operation due to environmental change.

Gree Climat



## 4. Refrigerant System Diagram

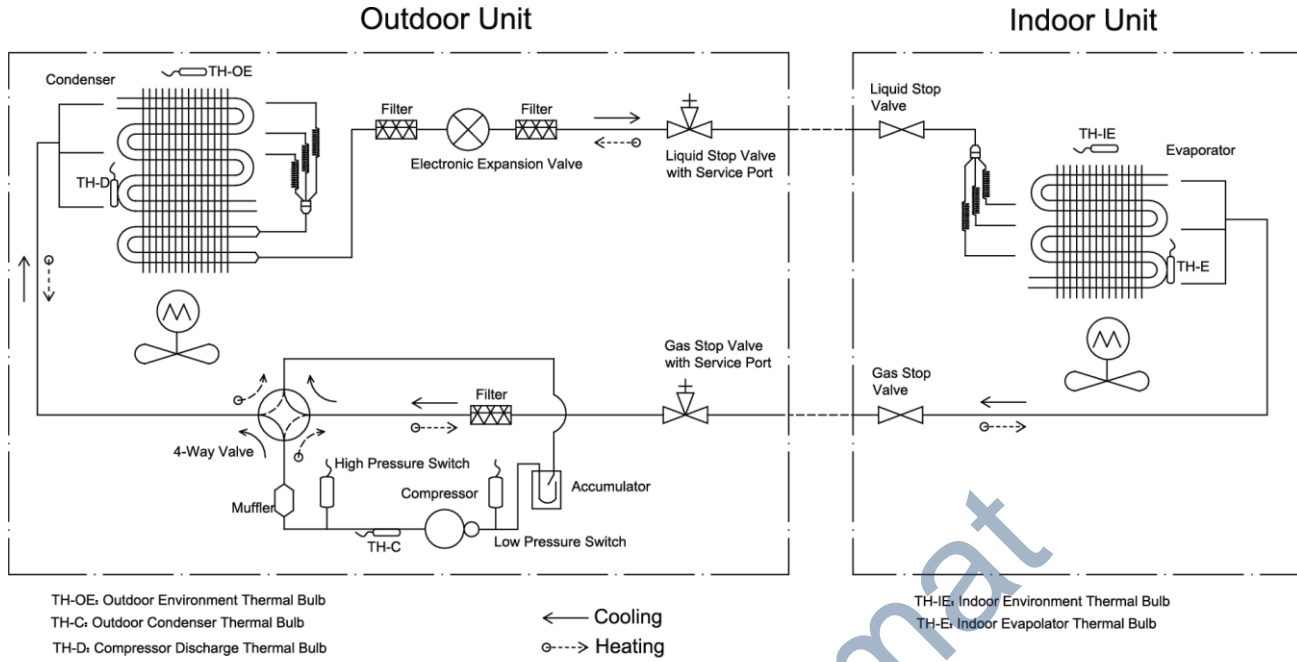









## 2. "+" or "-" button

- Press "+" or "-" button once increase or decrease set temperature 1°C. Holding "+" or "-" button, 2s later, set temperature on remote controller will change quickly. On releasing button after setting is finished, temperature indicator on indoor unit will change accordingly. (Temperature can't be adjusted under auto mode)
- When setting TIMER ON, TIMER OFF or CLOCK, press "+" or "-" button to adjust time. (Refer to CLOCK, TIMER ON, TIMER OFF buttons) When setting TIMER ON, TIMER OFF or CLOCK, press "+" or "-" button to adjust time. (Refer to CLOCK, TIMER ON, TIMER OFF buttons)









## 3. FAN button

Pressing this button can set fan speed circularly as: auto (AUTO), low( ) ,medium( ) ,high( ) .

## 4. MODE button

Press this button to select your required operation mode.



- When selecting auto mode, air conditioner will operate automatically according to exfactory setting. Set temperature can't be adjusted and will not be displayed as well. Press "FAN" button can adjust fan speed. Press "  " button can adjust fan blowing angle.
- After selecting cool mode, air conditioner will operate under cool mode. Cool indicator "  " on indoor unit is ON. Press "+" or "-" button to adjust set temperature. Press "FAN" button to adjust fan speed. Press "  " button to adjust fan blowing angle.
- When selecting dry mode, the air conditioner operates at low speed under dry mode. Dry indicator "  " on indoor unit is ON. Under dry mode, fan speed can't be adjusted. Press "  " button to adjust fan blowing angle.
- When selecting fan mode, the air conditioner will only blow fan, no cooling and no heating. all indicators are OFF. Press "FAN" button to adjust fan speed. Press "  " button to adjust fan blowing angle.
- When selecting heating mode, the air conditioner operates under heat mode. Heat indicator "  " on indoor unit is ON. Press "+" or "-" button to adjust set temperature, Press "FAN" button to adjust fan speed. Press "  " button to adjust fan blowing angle. (Cooling only unit won't receive heating mode signal. If setting heat mode with remote controller, press ON/OFF button can't start up the unit).

Note:

- For preventing cold air, after starting up heating mode, indoor unit will delay 1~5 minutes to blow air (actual delay time is depend on indoor ambient temperature).
- Set temperature range from remote controller: 16~30°C ; Fan speed: auto, low speed, medium speed, high speed.

## 5. I FEEL button

Press this button to turn on I FEEL function. The unit automatically adjust temperature according to the sensed temperature. Press this button again to cancel I FEEL function.



## 6. button

Press this button to set HEALTH function ON or OFF. After the unit is turned on, it defaults to HEALTH function ON.

## 7. button (Only available for some models)

Press this button to select AIR function ON or OFF.

## 8. CLOCK button



Press this button to set clock time. "  " icon on remote controller will blink. Press "+" or "-" button within 5s to set clock time. Each pressing of "+" or "-" button, clock time will increase or decrease 1 minute. If hold "+" or "-" button, 2s later, time will change quickly. Release this button when reaching your required time. Press "CLOCK" button to confirm the time. "  " icon stops blinking.

Note:



- Clock time adopts 24-hour mode.
- The interval between two operation can't exceeds 5s. Otherwise, remote controller will quit setting status. Operation for TIMER ON/ TIMER OFF is the same.

## 9. TIMER ON/TIMER OFF button

- TIMER ON button

"TIMER ON" button can set the time for timer on. After pressing this button, "  " icon disappears and the word "ON" on remote controller blinks. Press "+" or "-" button to adjust TIMER ON setting. After each pressing "+" or "-" button, TIMER ON setting will increase or decrease 1min. Hold "+" or "-" button, 2s later, the time will change quickly until reaching your required time. Press "TIMER ON" to confirm it. The word "ON" will stop blinking. "  " icon resumes displaying. Cancel TIMER ON: Under the condition that TIMER ON is started up, press "TIMER ON" button to cancel it.

- TIMER OFF button

"TIMER OFF" button can set the time for timer off. After pressing this button, "  " icon disappears and the word "OFF" on remote controller blinks. Press "+" or "-" button to adjust TIMER OFF setting. After each pressing "+" or "-" button, TIMER OFF setting will increase or decrease 1min. Hold "+" or "-" button, 2s later, the time will change quickly until reaching your required time. Press "TIMER OFF" word "OFF" will stop blinking. "  " icon resumes displaying. Cancel TIMER OFF. Under the condition that TIMER OFF is started up, press "TIMER OFF" button to cancel it.

Note:









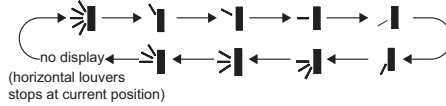

- Under on and off status, you can set TIMER OFF or TIMER on simultaneously.
- Before setting TIMER ON or TIMER OFF, please adjust the clock time.



- After starting up TIMER ON or TIMER OFF, set the constant circulating valid. After that, air conditioner will be turned on or turned off according to setting time. ON/OFF button has no effect on setting. If you don't need this function, please use remote controller to cancel it.

#### 10. button



Press this button can select up&down swing angle. Fan blow angle can be selected circularly as below:



- When selecting "  ", air conditioner is blowing fan automatically. Horizontal louver will automatically swing up & down at maximum angle.
- When selecting "  ,  ,  ,  ,  ", air conditioner is blowing fan at fixed position. Horizontal louver will stop at the fixed position.
- When selecting "  ,  ,  ", air conditioner is blowing fan at fixed angle. Horizontal louver will send air at the fixed angle.
- Hold "  " button above 2s to set your required swing angle. When reaching your required angle, release the button.

Note:  
 "  ,  ,  " may not be available. When air conditioner receives this signal, the air conditioner will blow fan automatically.



#### 11. X-FAN button

Press this button under cool and dry mode to start up x-fan function, and "  " icon on remote controller will be displayed. Press this button again to cancel x-fan function, and "  " icon will disappear.

#### 12. TEMP button

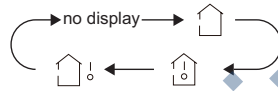
By pressing this button, you can see indoor set temperature, indoor ambient temperature or outdoor ambient temperature on indoor unit's display. The setting on remote controller is selected circularly as below:





When selecting "  " or no display with remote controller, temperature indicator on indoor unit displays set temperature;  
 When selecting "  " with remote controller, temperature indicator on indoor unit displays indoor ambient temperature;  
 When selecting "  " with remote controller, temperature indicator on indoor unit displays outdoor ambient temperature.

- Note:
- Outdoor temperature display is not available for some models. At that time, indoor unit receives "  " signal, while it displays indoor set temperature.
  - It's defaulted to display set temperature when turning on the unit. There is no display in the remote controller.
  - Only for the models whose indoor unit has dual-8 display



#### 13. TURBO button

Under COOL or HEAT mode, press this button to turn to quick COOL or quick HEAT mode. "  " icon is displayed on remote controller. Press this button again to exit turbo function and "  " icon will disappear.

#### 14. SLEEP button

Under COOL, HEAT mode, press this button to start up sleep function. "  " icon is displayed on remote controller. Press this button again to cancel sleep function and "  " icon will disappear.

#### 15. LIGHT button

Pressing this button to turn off display light on indoor unit. "  " icon on remote controller disappears. Press this button again to turn on display light. "  " icon is displayed.

## Function Introduction for Combination Buttons

#### Child lock function:

Press "+" and "-" simultaneously to turn on or turn off child lock function. When child lock function is on, "  " icon is displayed on remote controller. If you operate the remote controller, it won't send signal.

#### Temperature display switchover function:

Under OFF status, press "-" and "MODE" buttons simultaneously to switch temperature display between °C and °F.

## Operation Guide

1. After putting through the power, press "ON/OFF" button on remote controller to turn on the air conditioner.
2. Press "MODE" button to select your required mode: AUTO, COOL, DRY, FAN, HEAT.
3. Press "+" or "-" button to set your required temperature. (Temperature can't be adjusted under auto mode).
4. Press "FAN" button to set your required fan speed: auto, low, medium and high speed.
5. Press "  " button to select fan blowing angle.

## Replacement of Batteries in Remote Controller

1. Press the back side of remote controller marked with “” as shown in the fig, and then push out the cover of battery box along the arrow direction.
2. Replace two 7# (AAA 1.5V) dry batteries, and make sure the position of “+” polar and “-“ polar are correct.
3. Reinstall the cover of battery box.

### Note:

- During operation, point the remote control signal sender at the receiving window on indoor unit.
- The distance between signal sender and receiving window should be no more than 8m, and there should be no obstacles between them.
- Signal may be interfered easily in the room where there is fluorescent lamp or wireless telephone; remote controller should be close to indoor unit during operation.
- Replace new batteries of the same model when replacement is required.
- When you don't use remote controller for a long time, please take out the batteries.
- If the display on remote controller is fuzzy or there's no display, please replace batteries.

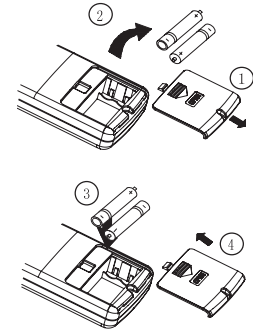

Sketch map for replacing batteries

Gree Climat

## 6.2 Brief Description of Modes and Functions

### 1. Basic function of system

#### (1) Cooling mode

- (1) Under this mode, fan and swing operates at setting status. Temperature setting range is 16~30°C.
- (2) During malfunction of outdoor unit or the unit is stopped because of protection, indoor unit keeps original operation status.

#### (2) Drying mode

- (1) Under this mode, fan operates at low speed and swing operates at setting status. Temperature setting range is 16~30°C.
- (2) During malfunction of outdoor unit or the unit is stopped because of protection, indoor unit keeps original operation status.
- (3) Protection status is same as that under cooling mode.
- (4) Sleep function is not available for drying mode.

#### (3) Heating mode

- (1) Under this mode, Temperature setting range is 16~30°C.
- (2) Working condition and process for heating mode:

When turn on the unit under heating mode, indoor unit enters into cold air prevention status. When the unit is stopped or at OFF status, and indoor unit has been started up just now, the unit enters into residual heat-blowing status.

#### (4) Working method for AUTO mode:

1. Working condition and process for AUTO mode:

a. Under AUTO mode, standard heating  $T_{\text{preset}}=20^{\circ}\text{C}$  and standard cooling  $T_{\text{preset}}=25^{\circ}\text{C}$ . The unit will switch mode automatically according to ambient temperature.

2. Protection function

- a. During cooling operation, protection function is same as that under cooling mode.
- b. During heating operation, protection function is same as that under heating mode.
3. Display: Set temperature is the set value under each condition. Ambient temperature is ( $T_{\text{amb.}}-T_{\text{compensation}}$ ) for heat pump unit and  $T_{\text{amb.}}$  for cooling only unit.
4. If there's I feel function,  $T_{\text{compensation}}$  is 0. Others are same as above.

#### (5) Fan mode

Under this mode, indoor fan operates at set fan speed. Compressor, outdoor fan, 4-way valve and electric heating tube stop operation. Indoor fan can select to operate at high, medium, low or auto fan speed. Temperature setting range is 16~30°C.

### 2. Other control

#### (1) Buzzer

Upon energization or availablely operating the unit or remote controller, the buzzer will give out a beep.

#### (2) Auto fan

Heating mode: During auto heating mode or normal heating mode, auto fan speed will adjust the fan speed automatically according to ambient temperature and set temperature.

#### (3) Sleep

After setting sleep function for a period of time, system will adjust set temperature automatically.

#### (4) Timer function:

General timer and clock timer functions are compatible by equipping remote controller with different functions.

#### (5) Memory function

memorize compensation temperature, off-peak energization value.

Memory content: mode, up&down swing, light, set temperature, set fan speed, general timer (clock timer can't be memorized).

After power recovery, the unit will be turned on automatically according to memory content.

#### (6) Health function (Health function is not available for this unit.)

During operation of indoor fan, set health function by remote controller. Turn off the unit will also turn off health function.

Turn on the unit by pressing auto button, and the health is defaulted ON.

### **(7) I feel control mode**

After controller received I feel control signal and ambient temperature sent by remote controller, controller will work according to the ambient temperature sent by remote controller.

### **(8) Compulsory defrosting function**

(1) Start up compulsory defrosting function

Under ON status, set heating mode with remote controller and adjust the temperature to 16°C. Press “+, -, +, -, +,-” button successively within 5s and the complete unit will enter into compulsory defrosting status. Meanwhile, heating indicator on indoor unit will ON 10s and OFF 0.5s successively. (Note: If complete unit has malfunction or stops operation due to protection, compulsory defrosting function can be started up after malfunction or protection is resumed.

(2) Exit compulsory defrosting mode

After compulsory defrosting is started up, the complete unit will exit defrosting operation according to the actual defrosting result, and the complete unit will resume normal heating operation.

### **(9) Refrigerant recovery function:**

(1) Enter refrigerant recycling function

Within 5min after energizing (unit ON or OFF status is ok), continuously press LIGHT button for 3 times within 3s to enter refrigerant recycling mode; Fo is displayed and refrigerant recycling function is started. At this moment, the maintenance people closes liquid valve. After 5min, stick the thimble of maintenance valve with a tool. If there is no refrigerant spraying out, close the gas valve immediately and then turn off the unit to remove the connection pipe.

(2) Exit refrigerant recycling function

After entering refrigerant recycling mode, when receive any remote control signal or enter refrigerant recycling mode for 25min, the unit will exit refrigerant recycling mode automatically. If the unit is in standby mode before refrigerant recycling, it will be still in standby mode after finishing refrigerant recycling; if the unit is in ON status before refrigerant recycling, it will still run in original operation mode.

### **(10) Ambient temperature display control mode**

1. When user set the remote controller to display set temperature (corresponding remote control code: 01), current set temperature will be displayed.

2. Only when remote control signal is switched to indoor ambient temperature display status (corresponding remote control code: 10) from other display status (corresponding remote control code: 00, 01, 11), controller will display indoor ambient temperature for 3s and then turn back to display set temperature.

Under this mode, indoor fan operates at set fan speed. Compressor, outdoor fan, 4-way valve and electric heating tube stop operation. Indoor fan can select to operate at high, medium, low or auto fan speed. Temperature setting range is 16~30°C.

### **(11) Off-peak energization function:**

Adjust compressors minimum stop time. The original minimum stop time is 180s and then we change to:

The time interval between two start-ups of compressor can't be less than  $180+T$  s ( $0 \leq T \leq 15$ ). T is the variable of controller. That's to say the minimum stop time of compressor is 180s~195s. Read-in T into memory chip when refurbish the memory chip each time. After power recovery, compressor can only be started up after  $180+T$  s at least.

### **(12) SE control mode**

The unit operates at SE status.

### **(13) X-fan mode**

When X-fan function is turned on, after turn off the unit, indoor fan will still operate at low speed for 2min and then the complete unit will be turned off. When x-fan function is turned off, after turn off the unit, the complete unit will be turned off directly.

### **(14) 8°C heating function**

Under heating mode, you can set 8°C heating function by remote controller. The system will operate at 8°C set temperature.

### **(15) Turbo fan control function**

Set turbo function under cooling or heating mode to enter into turbo fan speed. Press fan speed button to cancel turbo wind.

No turbo function under auto, dry or fan mode.



# Part II : Installation and Maintenance

## 7. Indoor Unit Installation

### 7.1 Installation of Floor Ceiling Type

#### 7.1.1 Before Installation

After receiving the machine, please check for any transport damage. If finding any surface or internal damage, please immediately report to the transport company or equipment company in writing.

After receiving the machine, please check the unit and accessories in reference to the packing list. Ensure that the model is correct and the machine is in good condition. Please also check if the specification and quantity of accessory parts are correct.

Determine the correct handling route and methods, thus to avoid damaging the unit or causing possible hazard. For the sake of protection and safety, it is suggested to move the unit with the packaging box. Even though it is not permitted to do like this under special occasions, do not remove the packaging box, thus to avoid loosening or falling during handling.

Confirm if the installing foundation is solid. When this unit is to be installed on the metal section of the building, make sure that the electrical insulation must comply with applicable standards.

Ensure that the place of installation is far from the area where the inflammable or explosive substances are stored, thus to avoid possible explosion or fire due to leakage.

#### 7.1.2 Installation Site

- (1) Install the unit at a place where is strong enough to withstand the weight of the unit.
- (2) The air inlet and outlet of the unit should never be clogged so that the airflow can reach every corner of the room.
- (3) Leave service space around the unit as required in Figure 3-1-49.

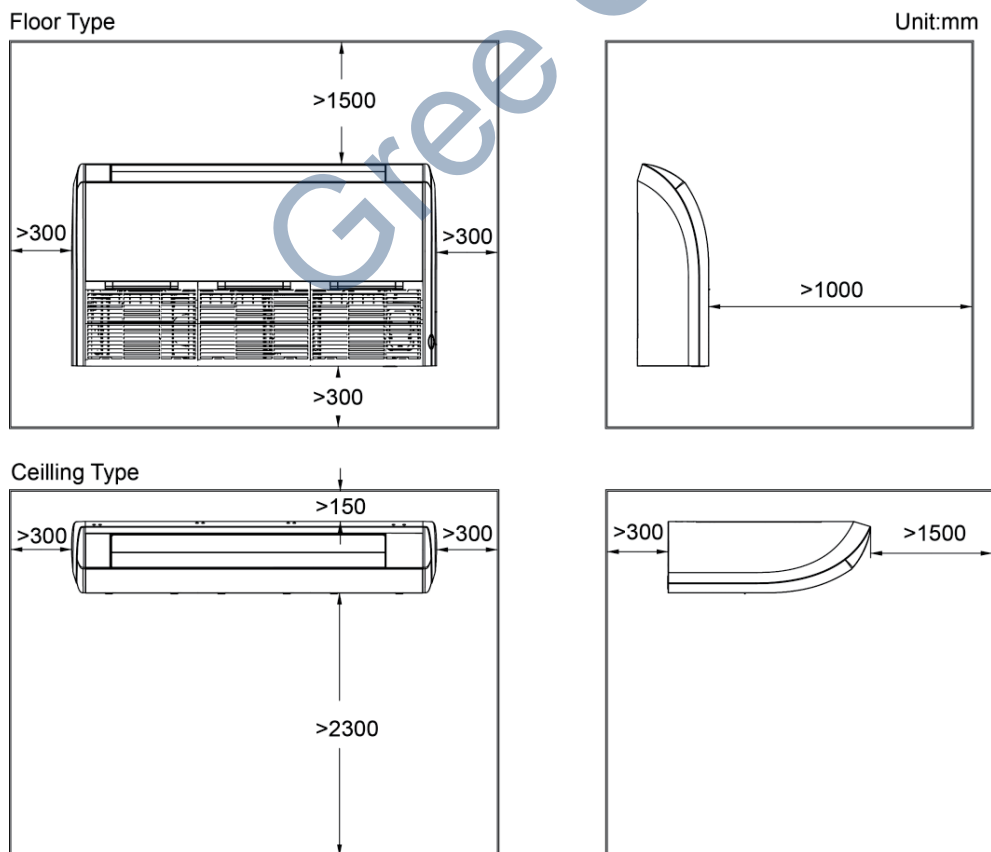

Figure 3-1-49

- (4) Install the unit where the drain pipe can be easily installed.
- (5) The space from the unit to the ceiling should be kept as much as possible so as for more



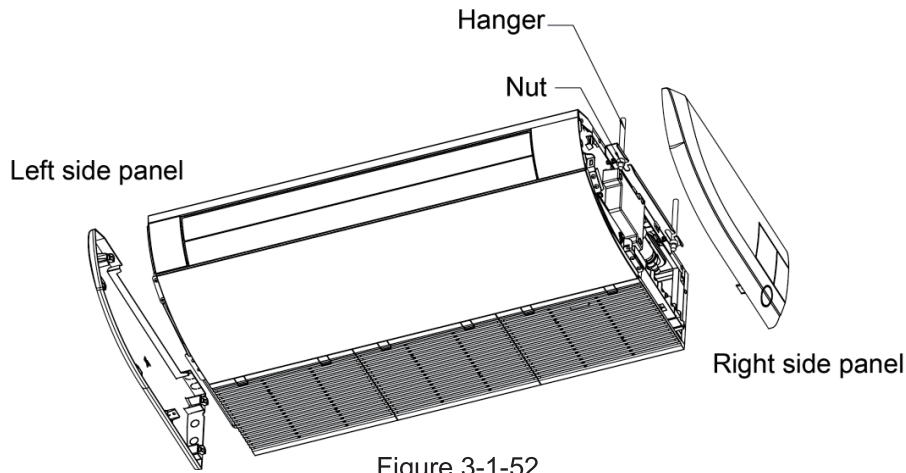
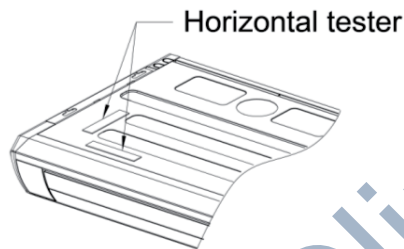

Figure 3-1-52

(6) Reinstall and tighten the right and left side panel.

### 7.1.4 Leveling

The water level test must be done after installing the indoor unit to make the unit is horizontal, as shown below.



### 7.1.5 Dimension Data

Figure 3-1-53

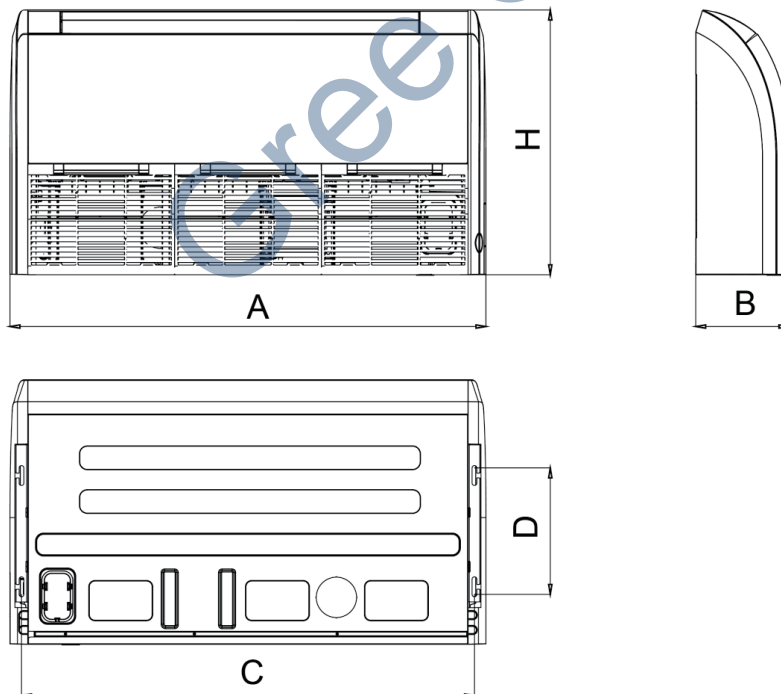

Figure 3-1-54  
Table 3-1-9

Unit: mm

Model	A	B	C	D	H
09/12/18K	870	235	812	318	665
24K	1200	235	1142	318	665



R - Metal clamp q - Insulation sponge.

- (4) When drain hose requires extension, obtain an extension hose commercially available.
- (5) After connecting the local drain hose, tape the slits of the heat insulation tube.
- (6) Connect the drain hose to the local drain pipe. Position the inter connecting wire in the same direction as the piping.

### 7.1.6.3 Connecting the Drain Hose

- (1) Connect the extension auxiliary pipe to the local piping.
- (2) Prepare the local piping at the connection point for the drain pipe, as shown in the installation drawings.

Note: Be sure to place the drain hose as shown in the diagram below, in a downward sloping direction.

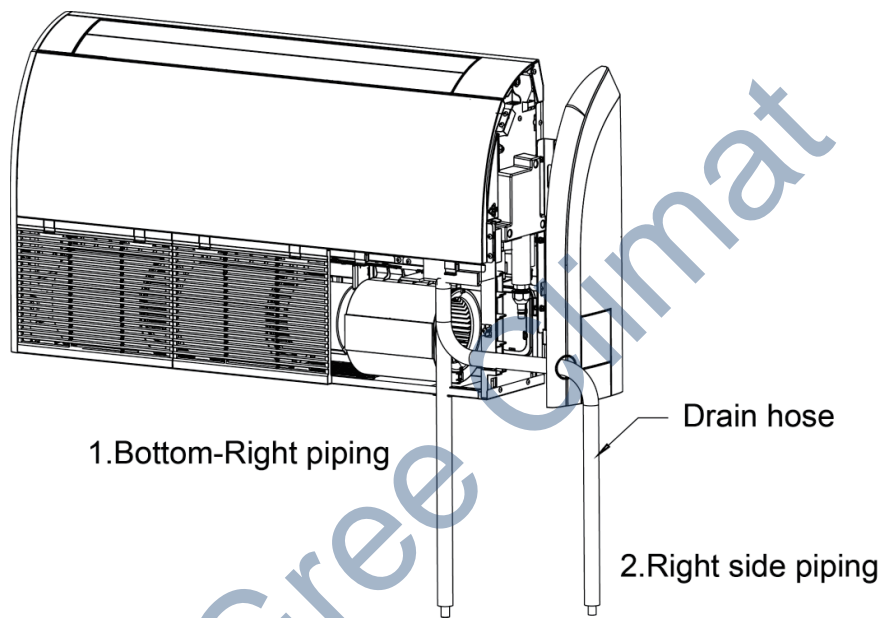

Figure 3-1-60

### 7.1.6.4 Testing of Drain Piping

- (1) After piping work is finished, check if drainage flows smoothly.
- (2) As shown in the figure, pour water into the drain pan from the right side to check that water flows smoothly from the drain hose.

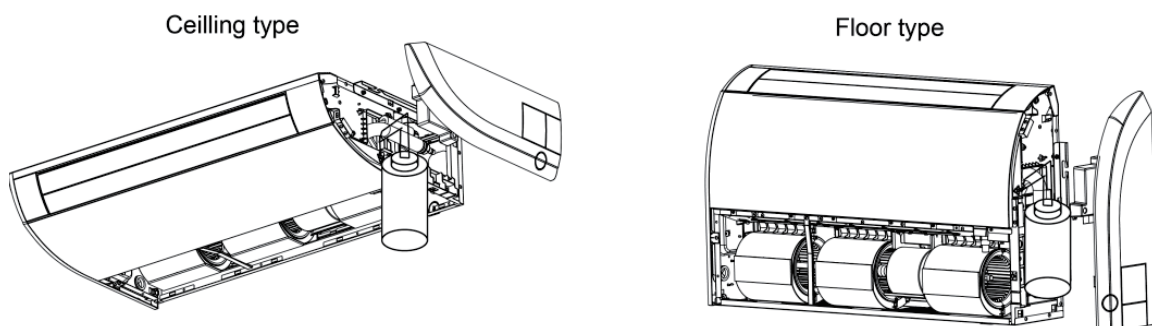



Figure 3-1-61

## 7.2 Electrical Wiring

### 7.2.1 Wiring Precautions

 <b>WARNING!</b>
1. Before obtaining access to terminals, all supply circuits must be disconnected.
2. The rated voltage of the unit is as shown as Table 3
3. Before turning on, verify that the voltage is within the 198-264V range (for single phrase unit)
4. Always use a special branch circuit and install a special receptacle to supply power to the air conditioner.
5. The special branch circuit breaker is installed in the permanent wiring. Always use a circuit that can trip all the poles of the wiring and has an isolation distance of at least 3 mm between the contacts of each pole.
6. Perform wiring work in accordance with standards so that the air conditioner can be operated safely and positively.
7. Install a leakage special branch circuit breaker in accordance with the related laws and regulations and electric company standards.
 <b>CAUTION!</b>
1. The power source capacity must be the sum of the air conditioner current and the current of other electrical appliances. When the current contracted capacity is insufficient, change the contracted capacity.
2. When the voltage is low and the air conditioner is difficult to start, contact the power company to raise the voltage.

### 5.5.2 Electrical Wiring

(1). For solid core wiring (Fig. 26)

- 1). Cut the wire end with a wire cutter or wire-cutting pliers, then strip the insulation about 25 mm (15/16").
- 2). Using a screwdriver, remove the terminal screw(s) on the terminal board.
- 3). Using pliers, bend the solid wire to form a loop suitable for the terminal screw.
- 4). Shape the loop wire properly, place it on the terminal board and tighten securely with the terminal screw using a screwdriver.

(2). For strand wiring (Fig. 26)

- 1). Cut the wire end with a wire cutter or wire-cutting pliers, then strip the insulation about 10 mm (3/8").
- 2). Using a screwdriver, remove the terminal screw (s) on the terminal board.
- 3). Using a round terminal fastener or pliers, securely clamp a round terminal to each stripped wire end.
- 4). Position the round terminal wire, and replace and tighten the terminal screw with a screwdriver. (Fig. 27)

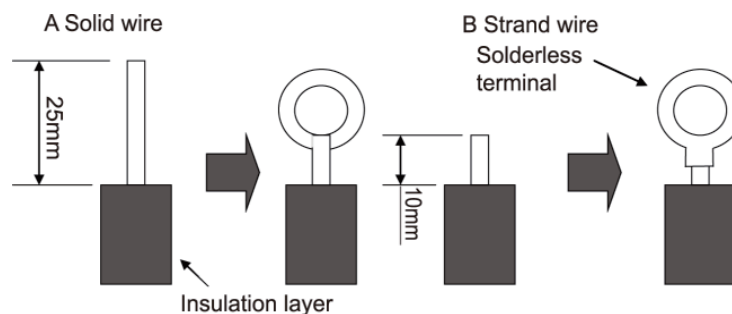

Fig. 26

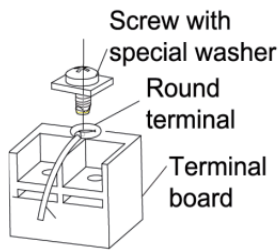

Fig. 27

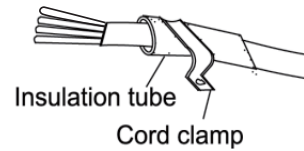
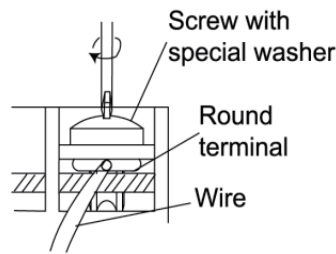



Fig. 28

(3). How to fix connection cord and power cord by cord clamp

After passing the connection cord fasten it with the cord clamp. (Fig. 28)

 <b>WARNING!</b>
1. Before starting work, check that power is not being supplied to the indoor unit and outdoor unit.
2. Match the terminal block numbers and connection cord colors with those of the indoor unit side.
3. Erroneous wiring may cause burning of the electric parts.
4. Connect the connection cords firmly to the terminal block. Imperfect installation may cause a fire.
5. Always fasten the outside covering of the connection cord with cord clamps. (If the insulator is not clamped, electric leakage may occur.)
6. Always connect the ground wire.

(4). Electric wiring between the indoor and outdoor units Single-phase units.

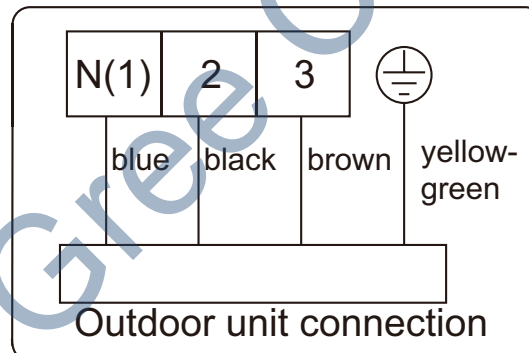

(5). Electric wiring of indoor unit side

Remove the left cover plate and the electric box cover then insert the end of the communication cord and the power cable into the terminal board.

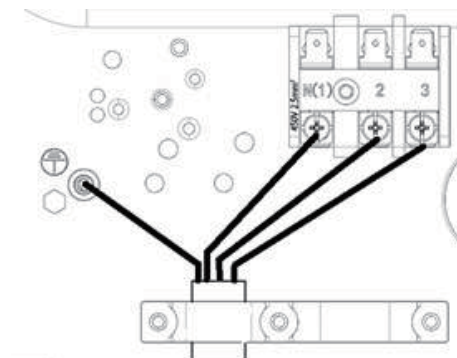
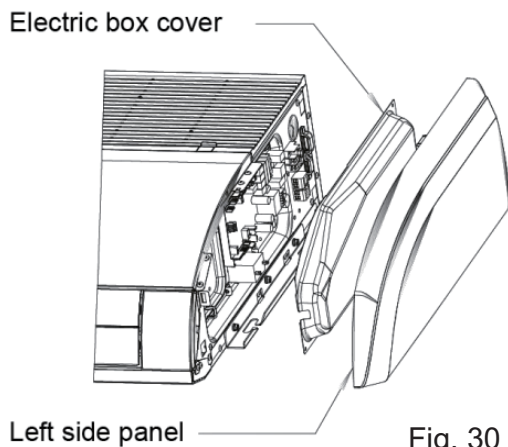



Fig. 30



# Safety Precautions

 <b>WARNING!</b>	This mark indicates procedures which, if improperly performed, might lead to the death or serious injury of the user.
 <b>CAUTION!</b>	This mark indicates procedures which, if improperly performed, might possibly result in personal harm to the user, or damage to property.

 **WARNING!**

- (1). For operating the air conditioner pleasantly, install it as outlined in this installation manual.
- (2). Connect the indoor unit and outdoor unit with the room air conditioner piping and cord available from our standard parts. This installation manual describes the correct connections using the installation set available from our standard parts.
- (3). Installation work must be performed in accordance with national wiring standards by authorized personnel only.
- (4). If refrigerant leaks while work is being carried out, ventilate the area. If the refrigerant comes in contact with a flame, it produces toxic gas.
- (5). Do not power on until all installation work is complete.
- (6). During installation, make sure that the refrigerant pipe is attached firmly before you run the compressor.  
Do not operate the compressor under the condition of refrigerant piping not attached properly with 2-way or 3-way valve open.  
This may cause abnormal pressure in the refrigeration cycle that leads to breakage and even injury.
- (7). During the pump-down operation, make sure that the compressor is turned off before you remove the refrigerant piping.  
Do not remove the connection pipe while the compressor is in operation with 2-way or 3-way valve open.  
This may cause abnormal pressure in the refrigerant cycle that leads to breakage and even injury.
- (8). When installing and relocating the air conditioner do not mix gases other than the specified refrigerant (R32) to enter the refrigerant cycle.  
If air or other gas enters the refrigerant cycle, the pressure inside the cycle will rise to an abnormally high value and cause breakage, injury, etc.
- (9). This appliance can be used by children aged from 8 years and above and persons with reduced physical, sensory or mental capabilities or lack of experience and knowledge if they have been given supervision or instruction concerning use of the appliance in a safe way and understand the hazards involved. Children shall not play with the appliance. Cleaning and user maintenance shall not be made by children without supervision.
- (10). If the supply cord is damaged, it must be replaced by the manufacturer, its service agent or similarly qualified persons in order to avoid a hazard.
- (11). Correct Disposal of this product
- (12). The appliance shall not be installed in the laundry.

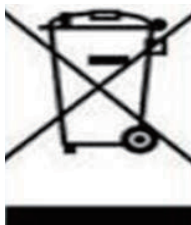

GWP:  
R32:675

This marking indicates that this product should not be disposed with other household wastes throughout the EU. To prevent possible harm to the environment or human health from uncontrolled waste disposal, recycle it responsibly to promote the sustainable reuse of material resources. To return your used device, please use the return and collection systems or contact the retailer where the product was purchased. They can take this product for environmental safe recycling.



## 8. Maintenance

### 8.1 Error Code List

Table 1 Fault Display on Indoor Wired Controller

No.	Error code	Malfunction name	Origin of malfunction signal	Control description
1	E1	High pressure protection	High pressure switch	When outdoor unit detects the high pressure switch is cut off for 3s successively, high pressure protection will occur. All the loads (except the 4-way valve in heating mode) will be switched off. In this case, all the buttons and remote control signals except ON/OFF button will be disabled and cannot be recovered automatically. Switch off the unit or re-energize the unit after cutting off power to eliminate this protection.
2	E2	Freeze protection	Indoor evaporator temperature sensor	If detecting that the evaporator temperature is lower than protective temp. Value after the unit has been running for a period of time under cooling or dry mode, the unit will report this fault, in which case the compressor and outdoor fan motor will be stopped. The unit will not run until evaporator temperature is higher than the protective temp. value and the compressor is stopped for 3min.
3	E3	Low pressure protection	Low pressure switch	If it is detected within 30s successively that the low-pressure switch is cut off under ON or standby state, the unit will report low pressure protection. If the fault occurs successively 3 times within 30min, the unit cannot be recovered automatically.
		Refrigerant lacking protection	-	If the unit reports system refrigerant lacking within 10min after turning on the unit, the unit will stop operation. If the fault occurs successively 3 times, the unit cannot be recovered automatically.
		Refrigerant recycling mode	-	If enter refrigerant recycling mode through special operation, E3 will be displayed. After exiting refrigerant recycling mode, the code will disappear.
4	E4	Compressor high discharge temperature protection	Compressor discharge temperature is high	If outdoor unit detects that the discharge temperature is higher than protective temp. Value, the unit will report high discharge temperature protection. If the protection occurs over 6 times, the unit cannot be recovered automatically. Switch off the unit or re-energize the unit after cutting off power to eliminate this protection.
5	E6	Communication malfunction	Communication between indoor and outdoor mainboard	If the outdoor unit does not receive data from indoor unit, communication malfunction will be reported. If there is communication abnormality between display board and indoor unit, communication malfunction will be reported too. If not powering on the outdoor unit, communication malfunction will be reported. (As for the 3 phase Power supply model, if the wrong connection, would be caused communication erro.)
6	F0	Malfunction of indoor ambient temperature sensor at air return port	Indoor ambient temperature sensor	If the indoor ambient temperature sensor is detected of open circuit or short circuit for 5s successively, indoor ambient temperature sensor malfunction will be reported. The unit can automatically resume operation after the malfunction disappears. If indoor ambient temperature sensor malfunction occurs in fan mode, only the error code is displayed and the indoor unit can work normally.
7	F1	Malfunction of evaporator temperature sensor	Evaporator temperature sensor	If the indoor evaporator temperature sensor is detected of open circuit or short circuit for 5s successively, evaporator temperature sensor malfunction will be reported. The unit can automatically resume operation after the malfunction disappears. If evaporator temperature sensor malfunction occurs in fan mode, only the error code is displayed and the indoor unit can work normally.
8	F2	Malfunction of condenser temperature sensor	Condenser temperature sensor	If the outdoor condenser temperature sensor is detected of open circuit or short circuit for 5s successively, condenser temperature sensor malfunction will be reported. The unit can automatically resume operation after the malfunction disappears. If condenser temperature sensor malfunction occurs in fan mode, only the error code is displayed and the indoor unit can work normally.

No.	Error code	Malfunction name	Origin of malfunction signal	Control description
9	F3	Malfunction of outdoor ambient temperature sensor	Outdoor ambient temperature sensor	If the outdoor ambient temperature sensor is detected of open circuit or short circuit for 5s successively, outdoor ambient temperature sensor malfunction will be reported. The unit can automatically resume operation after the malfunction disappears. If outdoor ambient temperature sensor malfunction occurs in fan mode, only the error code is displayed and the indoor unit can work normally.
10	F4	Malfunction of discharge temperature sensor	Discharge temperature sensor	If the outdoor discharge temperature sensor is detected of open circuit or short circuit for 5s successively after the compressor has been operating for 3min, outdoor discharge temperature sensor malfunction will be reported. The unit can automatically resume operation after the malfunction disappears.
11	F5	Malfunction wired controller temperature sensor	Wired controller	If the wired controller detects open circuit or short circuit of its temperature sensor for 5s successively, wired controller temperature sensor malfunction will be reported.
12	H3	Compressor overload protection	Compressor overload switch	If it is detected within 3s successively that the overload switch is cut off under ON or standby state, the unit will report overload protection. If the fault occurs successively 3 times, the unit cannot be recovered automatically. Switch off the unit or re-energize the unit after cutting off power to eliminate this protection.
13	H4	Overload protection	Evaporator temperature, condenser temperature	If outdoor unit detects that the tube temperature is higher than protective temp. Value, the unit will report overload protection. The unit will not restart operation until tube temperature is lower than the protective temp. Value and the compressor is stopped for 3min. If the protection occurs over 6 times, the unit cannot be recovered automatically. Switch off the unit or re-energize the unit after cutting off power to eliminate this protection.
14	CC	Long-distance monitor or centralized controller has set the shielding function	long-distance monitor or centralized controller	When the unit is connected to long-distance monitor or centralized controller, shielding function (including ON/OFF setting for shielding function, temperature setting for shielding function, SE setting for shielding function or all lock setting) can be set through long-distance monitor or centralized controller. When all lock is set, "cc" code will be always displayed on the indoor unit. When setting other shielding function, "CCfi" code will be displayed for 1s after receiving the remote control signal. This is the normal function for the unit. After cancel shielding function through long-distance monitor or centralized controller, this code will disappear automatically.

◆ E1 High Pressure Protection

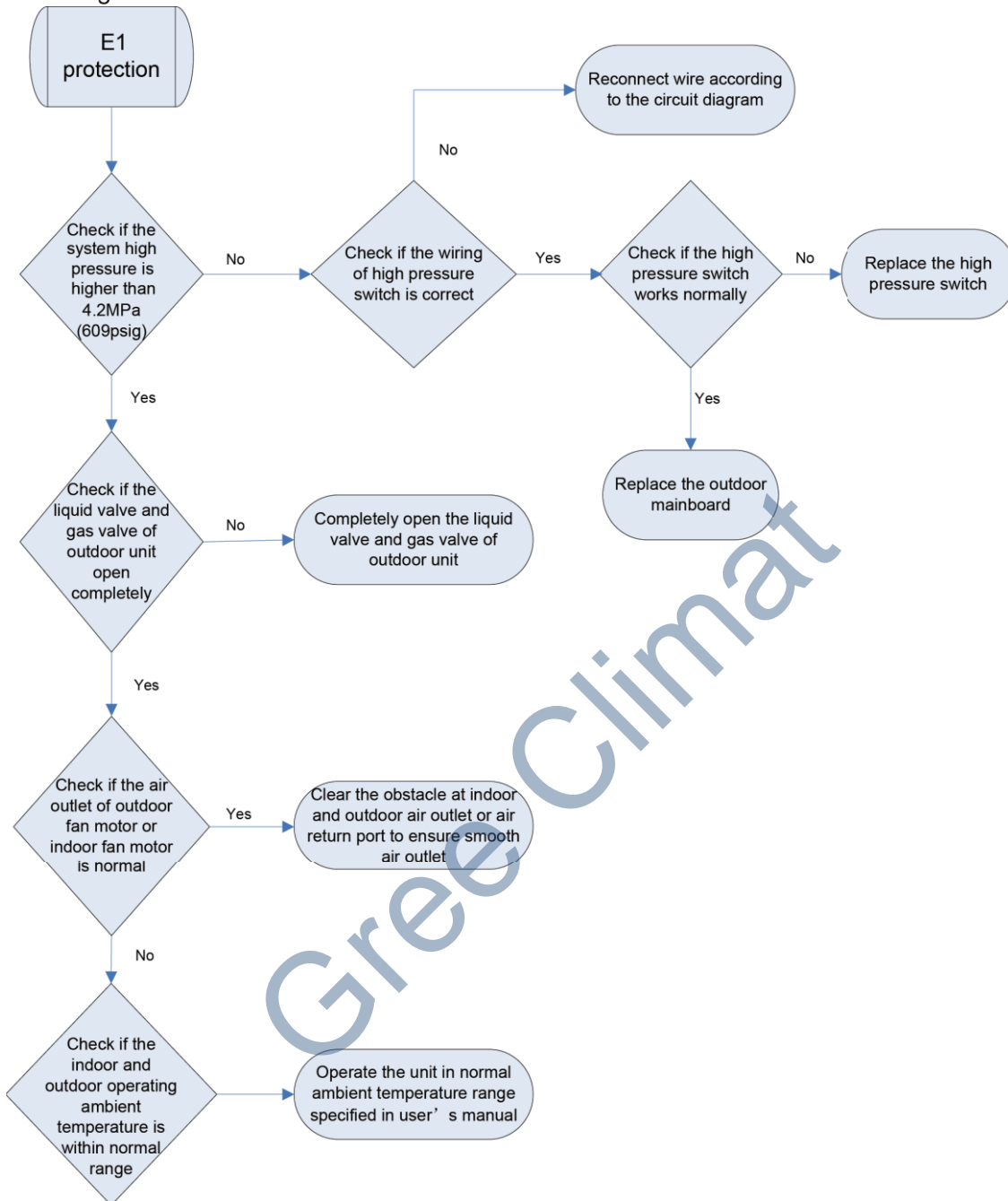

◆ E2 Freeze Protection

Freeze protection is normal protection but not abnormal malfunction. If freeze protection occurs frequently during operation, please check if the indoor filter is with filth blockage or if the indoor air outlet is abnormal. The user is required to clean the filter, check the air outlet and air return pipe periodically to ensure smooth air return and air outlet.

◆ E3 stands for three statuses:

- (1) Low pressure protection;
- (2) Refrigerant lacking protection;
- (3) Refrigerant recycling mode;



◆ E4 Discharge Protection

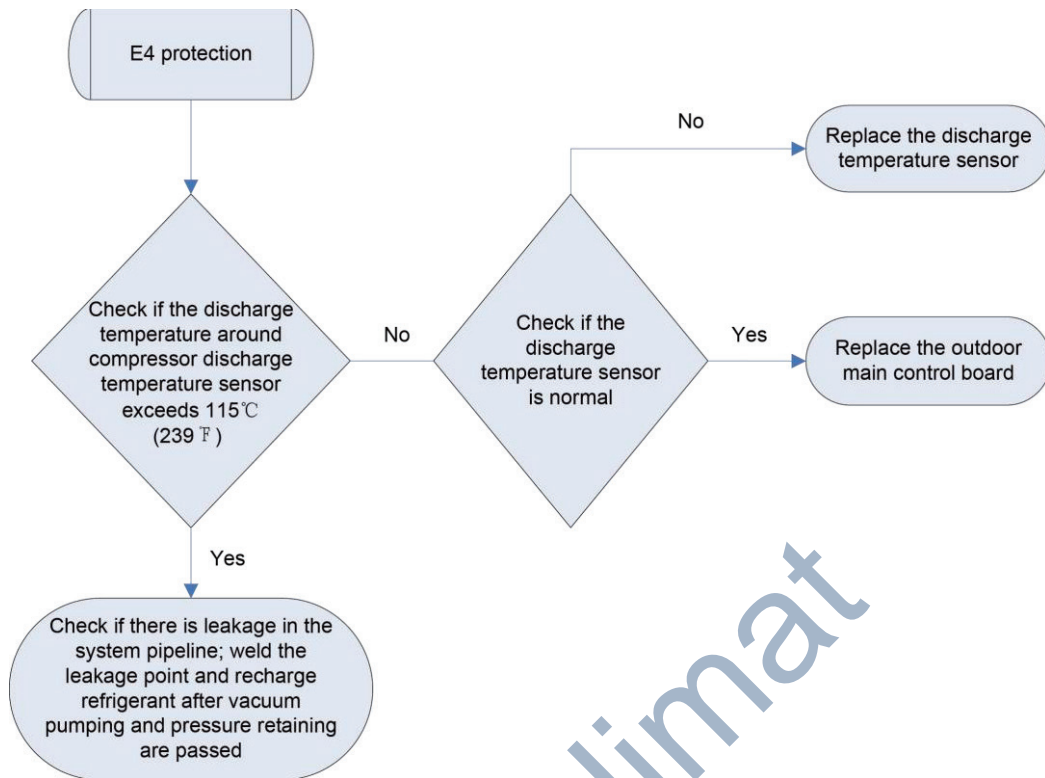

◆ E6 Communication Malfunction

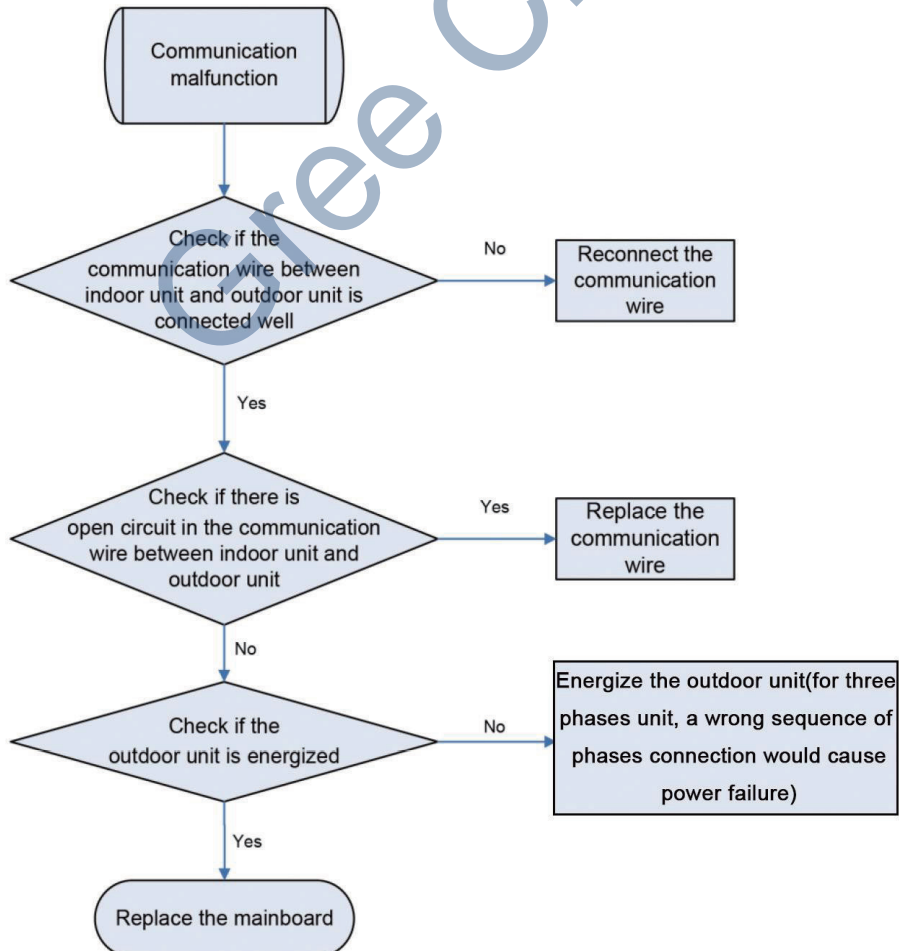



◆ F3 Malfunction of Outdoor Ambient Temperature Sensor

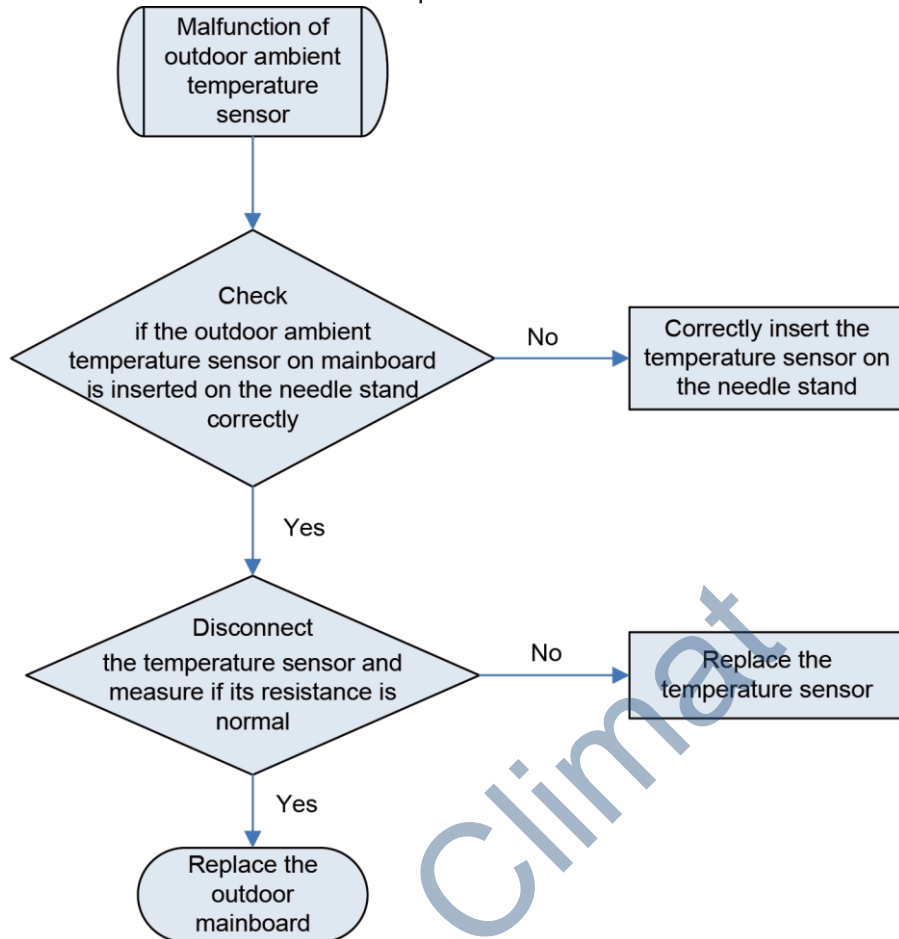

◆ F4 Malfunction of Discharge Temperature Sensor

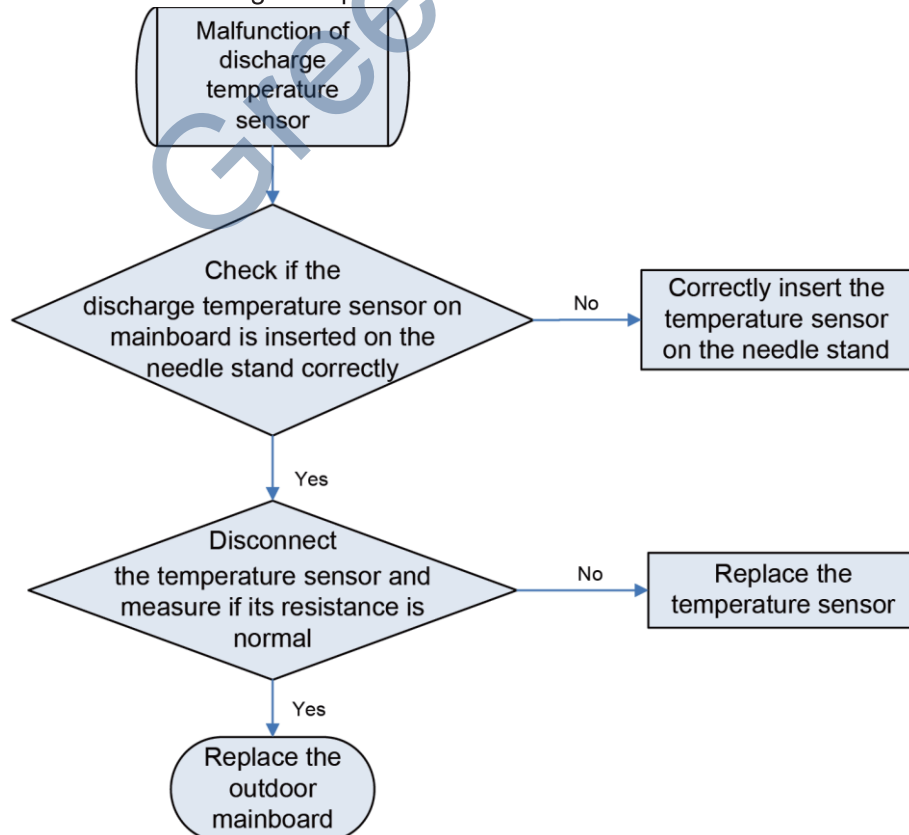



## 9. Exploded View and Parts List

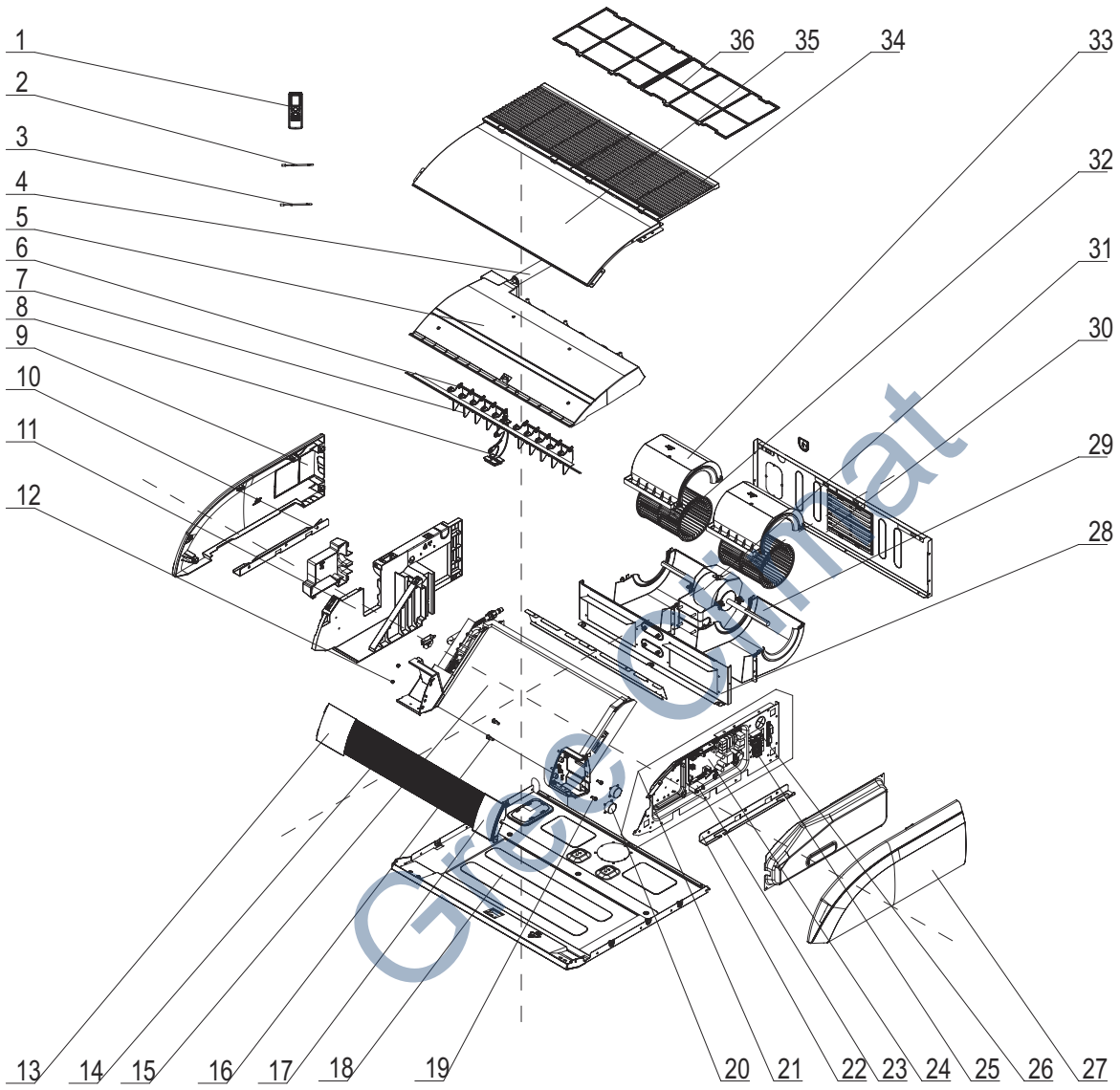

The component picture is only for reference; please refer to the actual product.

NO.	Description	Part Code			Qty
		GTH(09)CA-K6DNA1A/I	GTH(12)CA-K6DNA1A/I	GTH(18)CA-K6DNA1A/I	
	Product Code	CN610N0130	CN610N0140	CN610N0150	
1	Remote Controller	305100491	305100491	305100491	1
2	Temperature Sensor	3900020723	3900020723	3900020723	1
3	Room Sensor	39000191	39000191	39000191	1
4	Drainage Pipe Sub-Assy	05235434	05235434	05235434	1
5	Water Tray	200063000024	200063000024	200063000024	1
6	Swing Lever	10582009	10582009	10582009	2
7	Air Louver	200007000001	200007000001	200007000001	10
8	Supporter(Guide Louver)	26909400076	26909400076	26909400076	1
9	Right Cover Plate	26909400071	26909400071	26909400071	1
10	Installation Supporting Frame(Right)	01809402	01809402	01809402	1
11	Right Side Plate	26909400074	26909400074	26909400074	1
12	Axile Bush	10542704	10542704	10542704	2
13	Front Panel(Right Side Plate)	200003000001	200003000001	200003000001	1
14	Guide Louver	200004000046	200004000046	200004000046	2
15	Evaporator Assy	011001060120	011001000391	011001000497	1
16	Rotating Shaft 3	26909430	26909430	26909430	2
17	Display Board	30294000009	30294000009	30294000009	1
18	Base Plate Assy	011007000032	011007000032	011007000032	1
19	Crankshaft	200023000001	200023000001	200023000001	2
20	Stepping Motor	1521240206	1521240206	1521240206	2
21	Electric Box Assy	100002060574	100002060573	100002060572	1
22	Installation Supporting Frame(Left)	01809401	01809401	01809401	1
23	Capacitor	3301074716	3301074716	3301074716	1
24	Main Board	300002060140	300002060140	300002060140	1
25	Terminal Board	420001000002	420001000002	420001000002	1
26	Left Cover Plate	26909400070	26909400070	26909400070	1
27	Clapboard Sub-Assy	017021000088	017021000088	017021000088	1
28	Propeller Housing(Lower)	200230000001	200230000001	200230000001	2
29	Rear Side Plate Sub-Assy	017051000046	017051000046	017051000046	1
30	Fan Motor	1570940901	1570940901	1570940901	1
31	Centifugal Fan	103003000001	103003000001	103003000001	2
32	Propeller Housing(Upper)	200230000002	200230000002	200230000002	2
33	Front Grill	200226000004	200226000004	200226000004	2
34	Top Cover	012148000046P	012148000046P	012148000046P	1
35	Filter Sub-Assy	111001000001	111001000001	111001000001	1

Above data is subject to change without notice.

NO.	Description	Part Code		Qty
		GTH(24)CB-K6DNA2A/I		
		Product Code		
		CN610N0160		
1	Remote Controller	305100491		1
2	Temperature Sensor	390001923		1
3	Room Sensor	39000191		1
4	Drainage Pipe Sub-Assy	05235434		1
5	Water Tray	01289400017		1
6	Swing Lever	10582009		2
7	Air Louver	200007000001		10
8	Supporter(Guide Louver)	26909400076		1
9	Right Cover Plate	26909400071		1
10	Installation Supporting Frame(Right)	01809402		1
11	Right Side Plate	26909400074		1
12	Axile Bush	10542704		2
13	Front Panel(Right Side Plate)	200003000001		1
14	Guide Louver	200004500422		2
15	Evaporator Assy	011001060117		1
16	Rotating Shaft 3	26909430		2
17	Display Board	30294000009		1
18	Base Plate Assy	02229400036		1
19	Crankshaft	200023000001		2
20	Stepping Motor	1521240206		2
21	Electric Box Assy	100002060571		1
22	Installation Supporting Frame(Left)	01809401		1
23	Capacitor	3301074702		1
24	Main Board	300002060140		1
25	Terminal Board	420001000002		1
26	Left Cover Plate	26909400070		1
27	Clapboard Sub-Assy	01249400018		1
28	Propeller Housing(Lower)	200230000001		2
29	Rear Side Plate Sub-Assy	017051000005		1
30	Fan Motor	150101000102		1
31	Centifugal Fan	103003000001		2
32	Propeller Housing(Upper)	200230000002		2
33	Front Grill	26909400072		2
34	Top Cover	01269400012P		1
35	Filter Sub-Assy	111001000001		1

Above data is subject to change without notice.

# 10. Removal Procedure

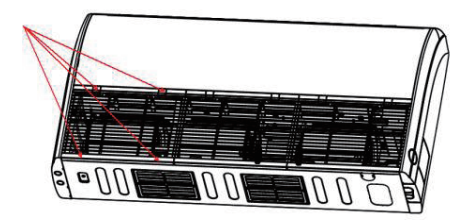
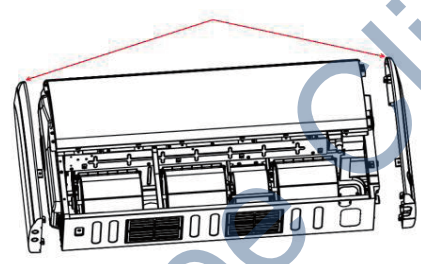
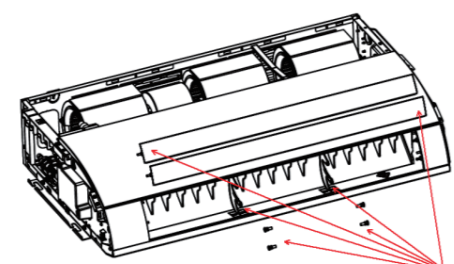
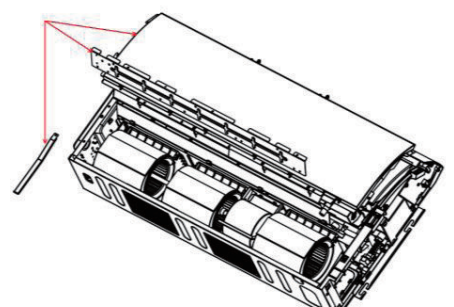

**Caution: discharge the refrigerant completely before removal.**

Disassembly of panel grating module		
Remark: Make sure that the power supply is cut off before disassembling and protect all the parts during disassembly. Do not put filter screen near the high temperature heat source.		
Step	Illustration	Handling Instruction
Disassembly of sub-assy of front grill		<ul style="list-style-type: none"> <li>•Unscrew the 2 clasps of the upper grill and the 2 screws of the clasps.</li> <li>•Open the grill, disassemble the 2 down clasps to remove the grill.</li> </ul>
Disassembly of right and left finishing plates		
Remark: Make sure the power supply is cut off before disassembling and protect all the parts during disassembly. Do not scratch the outer parts.		
Step	Illustration	Handling Instruction
Disassembly of right and left finishing plates		<ul style="list-style-type: none"> <li>•Disassemble the screws as shown in the graph with screwdriver and then push upward to remove the right and left finishing plates. (As is shown in the graph, arrow represents the position of screws.)</li> </ul>
Disassembly of panel parts		
Remark: Make sure the power supply is cut off before disassembling and protect all the parts during disassembly. Do not scratch the outer parts.		
Step	Illustration	Handling Instruction
1.Disassembly of sub-assy of air deflecting plate		<ul style="list-style-type: none"> <li>•Remove the air deflecting plates from the air deflecting plate support assembly.</li> </ul>
2.Disassembly of panel parts		<ul style="list-style-type: none"> <li>•Unscrew the sides' screws on the cover to remove the cover.</li> </ul>

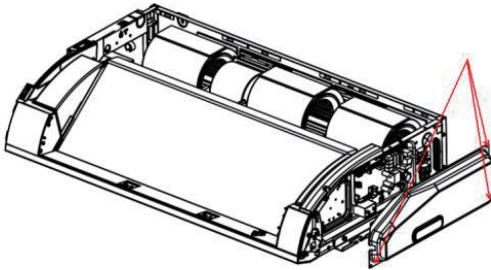
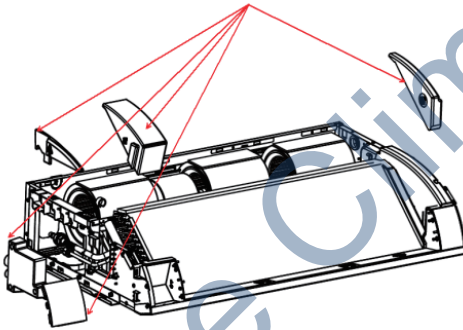
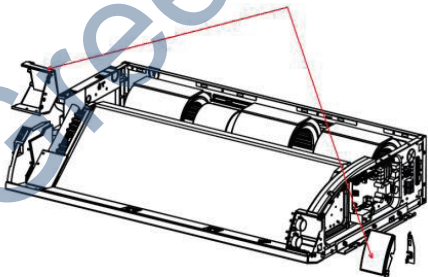
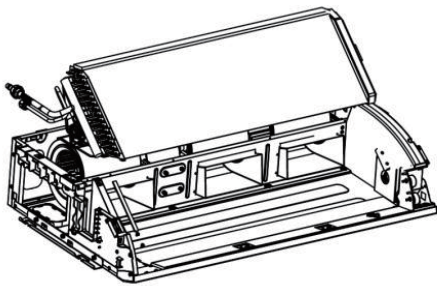
Disassembly of sub-assy of electric box		
Remark: Make sure that the power supply is cut off before disassembling and protect all the parts during disassembly, especially the components inside the box in case of water and hit.		
Step	Illustration	Handling Instruction
Disassembly of electric box cover		<ul style="list-style-type: none"> <li>Disassemble 3 screws as shown by the arrow in the graph on left and remove the electric box cover.</li> </ul>
Disassemble of foam and cover		
Remark: Make sure the power supply is cut off before disassembling and protect all the parts during disassembly.		
Step	Illustration	Handling Instruction
1. Disassemble of foam		<ul style="list-style-type: none"> <li>Remove the foam</li> </ul>
2. Disassemble of cover		<ul style="list-style-type: none"> <li>Unscrew the screws on the cover to remove the cover.</li> </ul>
Disassembly of evaporator components		
Remark: Make sure that the power supply is cut off and protect the copper tube and aluminum fin. If the time for disassembly shall be long, seal the copper tube.		
Step	Illustration	Handling Instruction
Disassembly of evaporator components		<ul style="list-style-type: none"> <li>Unscrew the screws of evaporator to remove the evaporator.</li> </ul>

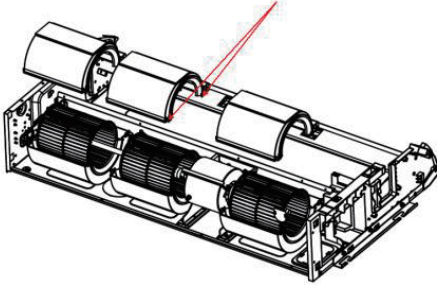
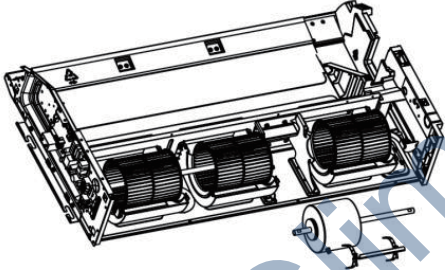
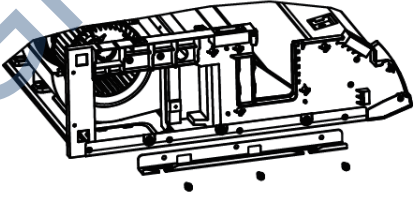
Disassembly of fan and motor components		
Remark: Make sure that the power supply is cut off before disassembling and protect all the parts during disassembly, especially the fastening screws for fans.		
Step	Illustration	Handling Instruction
1. Disassembly of front and back scroll cases		<ul style="list-style-type: none"> <li>● Press the buckle at the joints of front and back scroll cases with hands and pull upward to remove the front scroll case. Then remove the screws on the back scroll case. Lift the buckle of back scroll case with hands and remove it. (As is shown in the graph, circle represents 2 screws on left and right.)</li> </ul>
2. Disassembly of motor		<ul style="list-style-type: none"> <li>● Loosen the 2 screws of the motor attaching clamp, remove the motor attaching clamp and motor attaching clamp subassembly to remove the motor.</li> </ul>
Disassembly of right and left fixing plates		
Remark: Make sure that the power supply is cut off before disassembling and protect all the parts during disassembly.		
Step	Illustration	Handling Instruction
Disassembly of right and left fixing plates		<ul style="list-style-type: none"> <li>● Disassemble the bolts on right and left fixing plates with tools. (As is shown by the arrow in the graph.)</li> </ul>



JF00303628

Gree Climat



GREE ELECTRIC APPLIANCES, INC. OF ZHUHAI

Add: West Jinji Rd, Qianshan, Zhuhai,Guangdong, China, 519070  
Tel: (+86-756) 8522218  
Fax: (+86-756) 8669426  
E-mail: [gree@gree.com.cn](mailto:gree@gree.com.cn) [www.gree.com](http://www.gree.com)

HONG KONG GREE ELECTRIC APPLIANCES SALES LIMITED

Add: Unit 2612,26/F.,Miramar Tower 132 Nathan Road,TST,Kowloon,HK  
Tel: (852) 31658898 Fax: (852) 31651029

**For product improvement, specifications and appearance in this manual are subject to change without prior notice.**