



# Service Manual

Models: GVA24AL-K3NNC7A  
GVA48AL-M3NNC7A  
GVA55AL-M3NNC7A  
(Refrigerant:R410A)

Gree Climat

**GREE ELECTRIC APPLIANCES, INC. OF ZHUHAI**

## Table of Contents

<b>Part I : Technical Information</b> .....	1
<b>1. Summary</b> .....	1
<b>2. Specifications</b> .....	2
2.1 Specification Sheet.....	2
2.2 Operation Characteristic Curve.....	8
2.3 Cooling Data Sheet in Rated Frequency.....	8
2.4 Noise Curve.....	9
<b>3. Outline Dimension Diagram</b> .....	10
3.1 Indoor Unit.....	10
3.2 Outdoor Unit.....	11
<b>4. Refrigerant System Diagram</b> .....	12
<b>5. Electrical Part</b> .....	13
5.1 Wiring Diagram.....	13
5.2 PCB Printed Diagram.....	16
<b>6. Function and Control</b> .....	19
6.1 Function Buttons of Air Conditioner.....	19
6.2 Remote Control Operations.....	21
6.3 Introduction of Each Mode Function.....	25
<b>Part II : Installation and Maintenance</b> .....	30
<b>7. Notes for Installation and Maintenance</b> .....	30
<b>8. Installation</b> .....	33
8.1 Installation Dimension Diagram.....	33
8.2 Installation Parts-checking.....	35
8.3 Selection of Installation Location.....	35
8.4 Requirements for electric connection.....	35
8.5 Installation of Indoor Unit.....	36
8.6 Installation of Outdoor unit.....	37
8.7 Vacuum Pumping and Leak Detection.....	39
8.8 Check after Installation and Test Operation.....	39

<b>9. Maintenance</b> .....	40
9.1 Error Code List .....	40
9.2 Procedure of Troubleshooting .....	44
9.3 Maintenance Method for Normal Malfunction.....	53
<b>10. Exploded View and Parts List</b> .....	55
10.1 Indoor Unit.....	55
10.2 Outdoor Unit.....	59
<b>11. Removal Procedure</b> .....	63
11.1 Removal Procedure of Indoor Unit .....	63
11.2 Removal Procedure of Outdoor Unit .....	78
<b>Appendix:</b> .....	87
Appendix 1: Reference Sheet of Celsius and Fahrenheit .....	87
Appendix 2: Configuration of Connection Pipe.....	87
Appendix 3: Pipe Expanding Method .....	88
Appendix 4: List of Resistance for Temperature Sensor.....	89



















### 3. Outline Dimension Diagram

#### 3.1 Indoor Unit

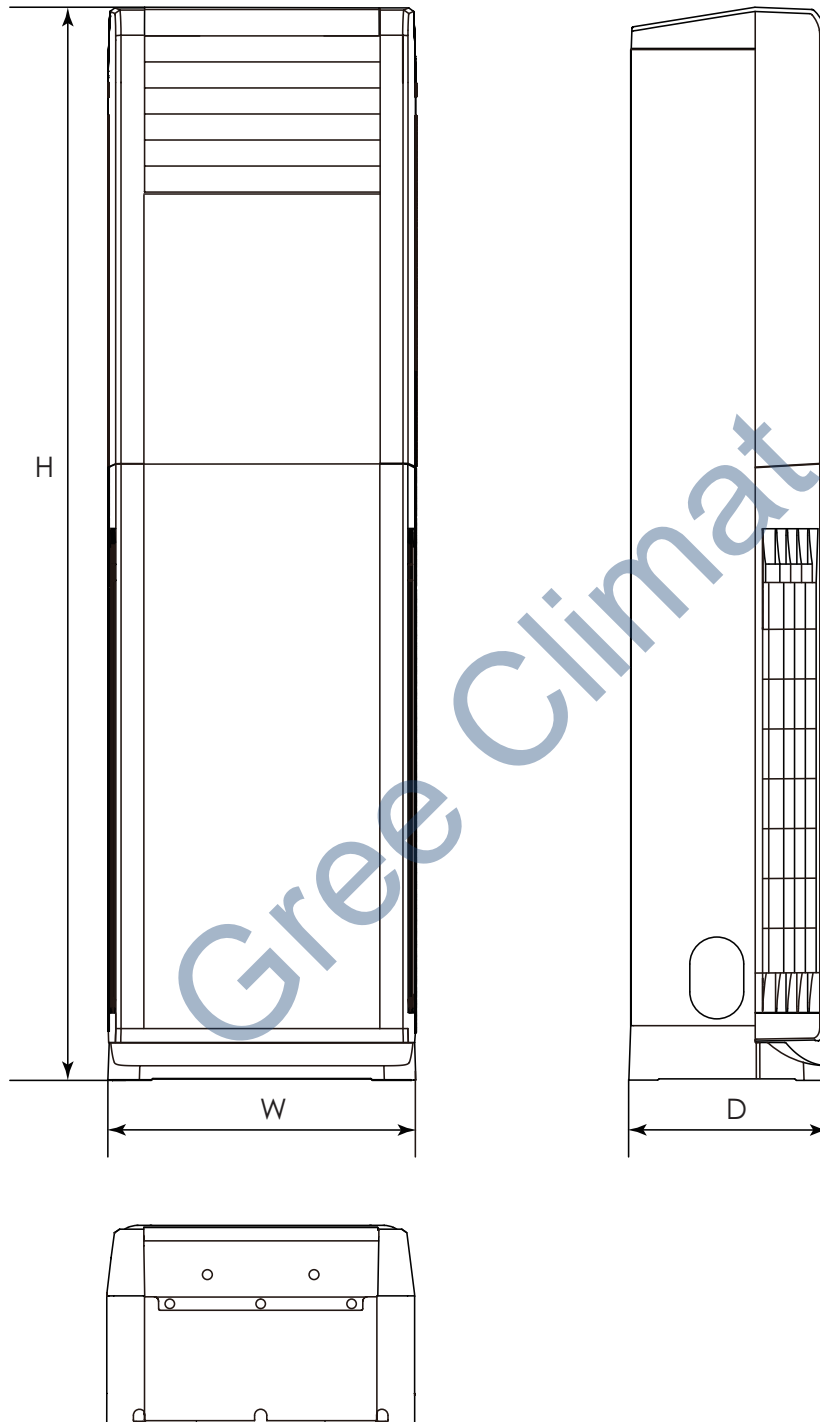

Unit:mm

Model	W	H	D
24K	507	1770	320
48/55K	587	1882	394





## 5. Electrical Part

### 5.1 Wiring Diagram

- Instruction

Symbol	Symbol Color	Symbol	Symbol Color	Symbol	Name
YE	Yellow	BN	Brown	COMP	Compressor
RD	Red	BU	Blue	⊕	Grounding wire
YEGN	Yellow/Green	BK	Black	/	/

- Indoor Unit

24K

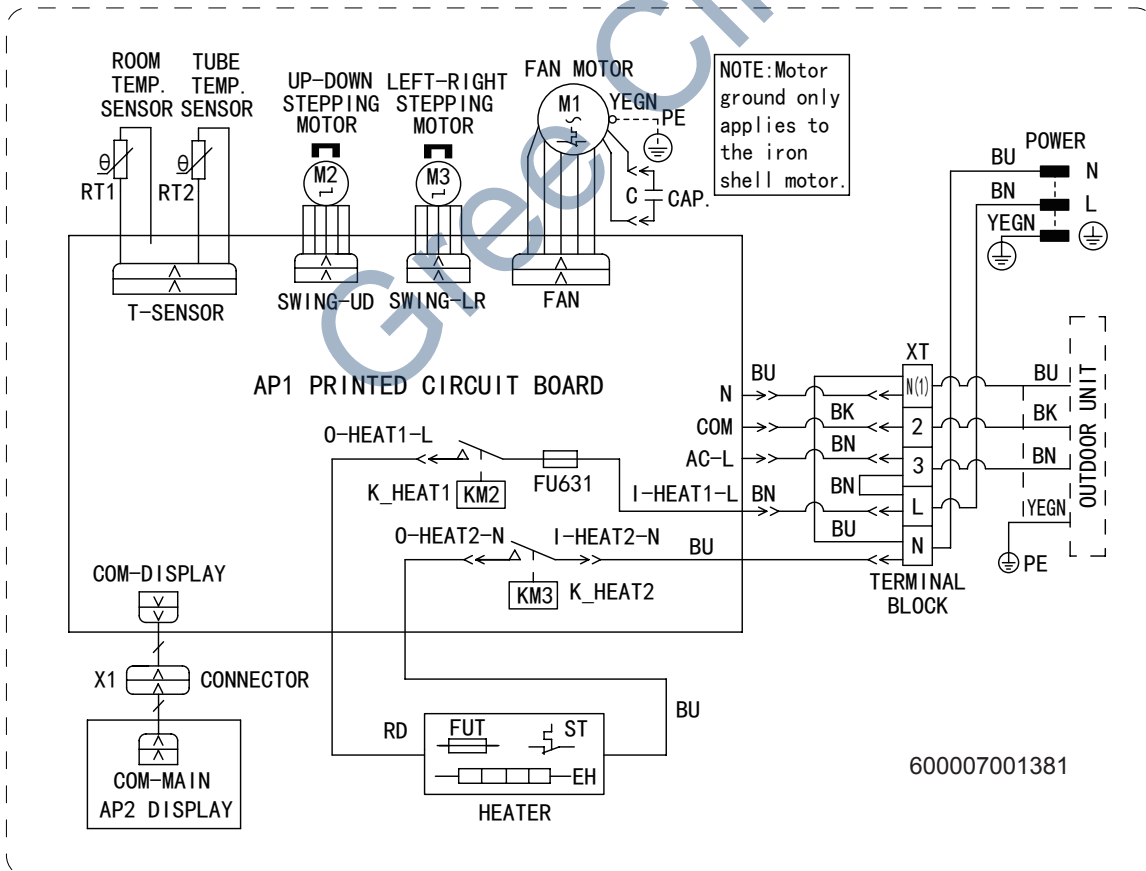



• Outdoor Unit

24K

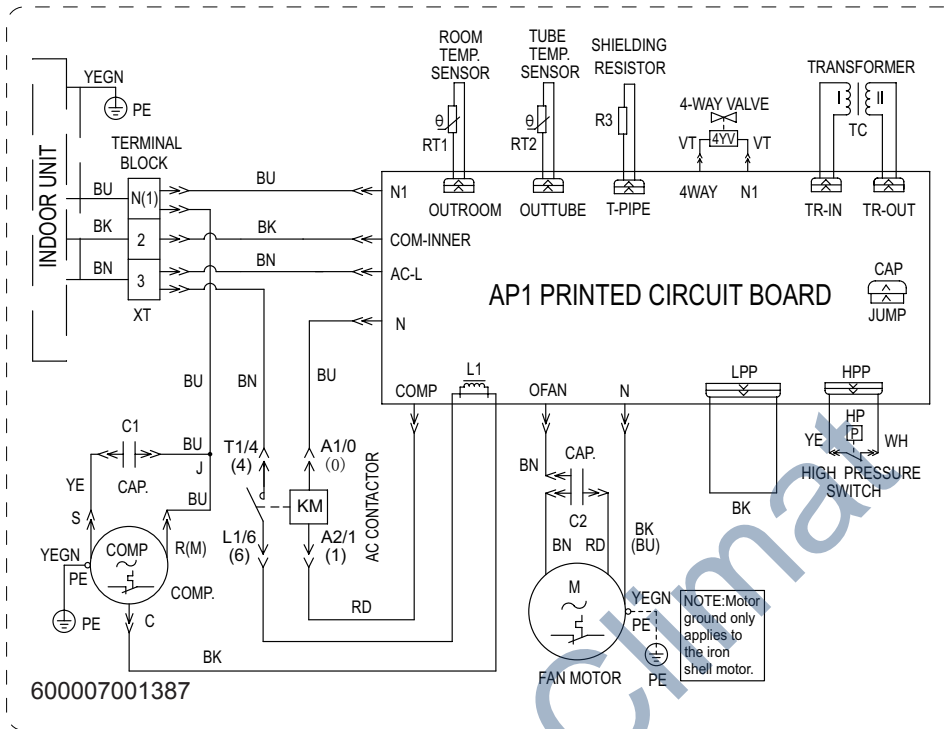

48/55K

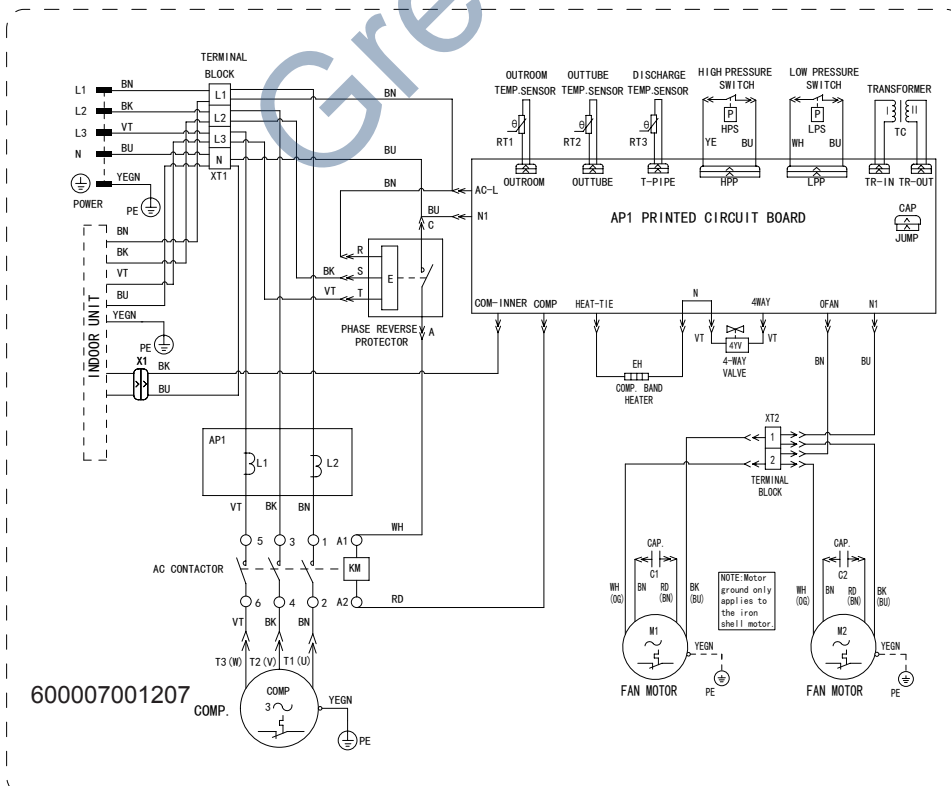

These wiring diagrams are subject to change without notice; please refer to the one supplied with the unit.



48/55K

• Top view

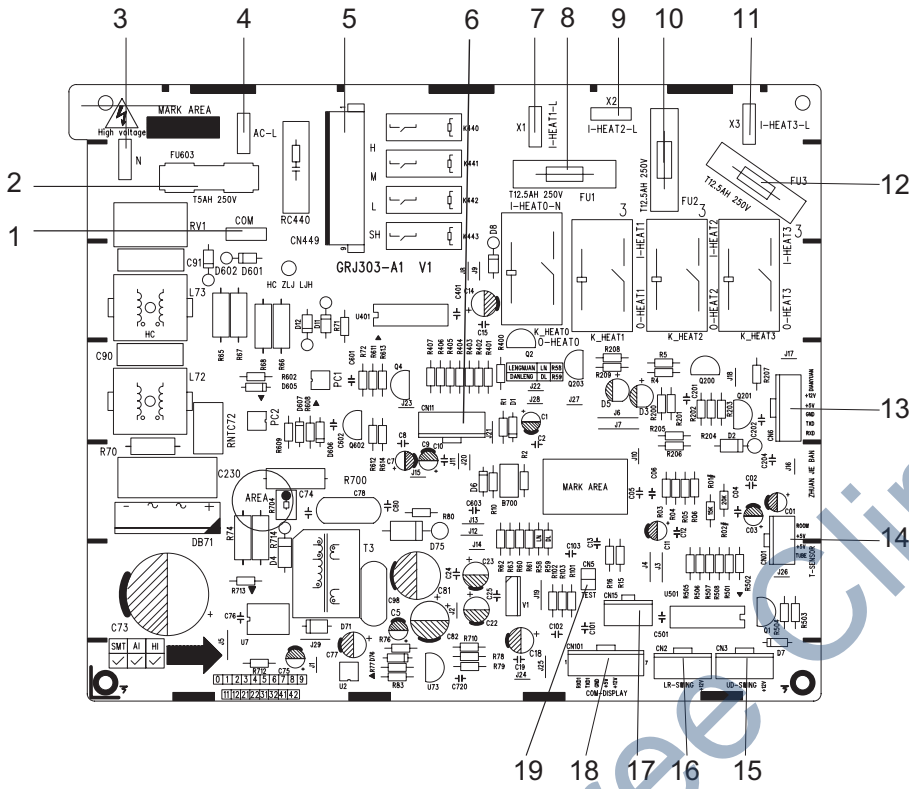

1	Compressor wiring terminal
2	Fuse
3	Interface of neutral wire
4	Interface of live wire
5	Needle stand for indoor fan
6	Needle stand of simulation port
7	Live wire terminal of E-heater1
8	Fuse of E-heater1
9	Live wire terminal of E-heater2
10	Fuse of E-heater2
11	Live wire terminal of E-heater3
12	Fuse of E-heater3
13	Needle stand connected with drive board of DC motor
14	Interface of temperature sensor
15	up&down swing interface
16	Left&right swing interface
17	RS485 Communication interface
18	connection with display board
19	Needle stand of fast-detection port

• Bottom view

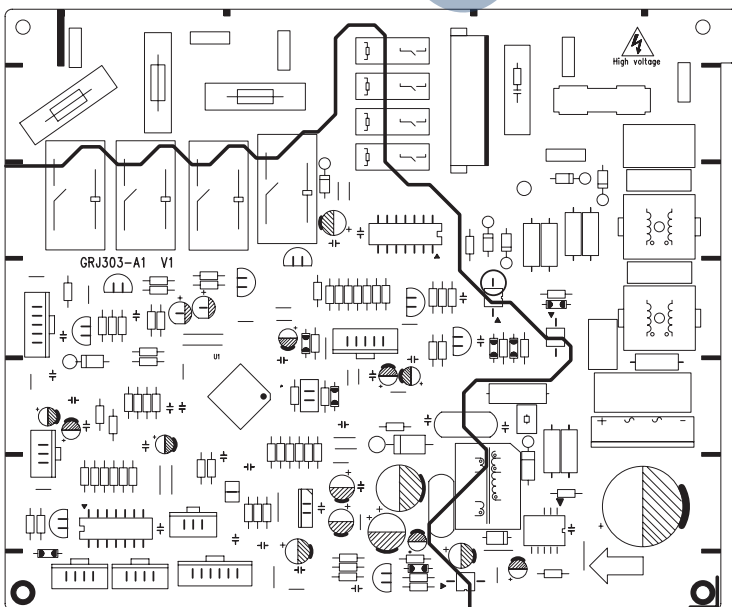



## 6. Function and Control

### 6.1 Function Buttons of Air Conditioner

#### Button's Name and Function

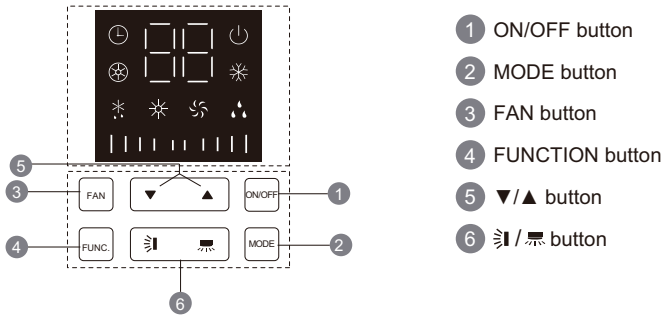

#### Introduction for icons on display screen of air conditioner

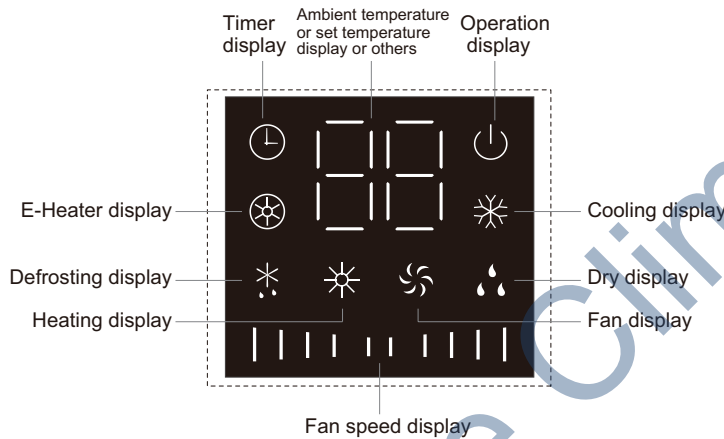

**Note:**

This series unit adopts touch buttons. You only need to touch the buttons slightly.

**1** ON/OFF button

- Press this button to turn on or turn off the unit. (Note: Under X-FAN mode, press this button to turn on the unit directly.)

**2** MODE button

- Every time press this button, the mode will switchover in cycle among.

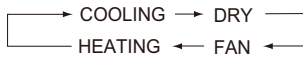

(Note: Cooling only unit won't accept heating operation signal. For cooling only unit, pressing MODE button under FAN mode will skip heating mode and enter cooling mode.)

**3** FAN button

- Press this button and then fan speed can be selected and displayed in the sequence as below:

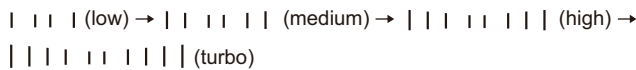

(Note: Only low fan speed is available for dry mode. Fan speed can't be adjusted under dry mode. Turbo cannot be set in FAN mode.)

**4** FUNCTION button



- Under on status, press Function button to switch between timer and auxiliary heating function setting (auxiliary heating can be set only in heating mode). When timer or auxiliary heating icon is blinking, it means this function can be set. Press "▲" or "▼" button to set function. If there's no operation change within 5s after setting is finished, the function setting will be confirmed. Or press Function button again to exit or confirm the function. When the function is selected through Function button, if the unit is not turned off and no remote control signal is received within 2min, pressing Function button again to circulate from the previous set function. After 2min or the unit is turned off or remote control signal is received, pressing Function button again to circulate from timer icon. (Note: Only when the unit is under heating mode and with auxiliary heating function, auxiliary heating function can be turned on or off through Function button.)
- Under off status, if the unit is in X-FAN status, press Function button to turn off the unit directly; if the unit is not in X-FAN status, press Function button to set timer ON.

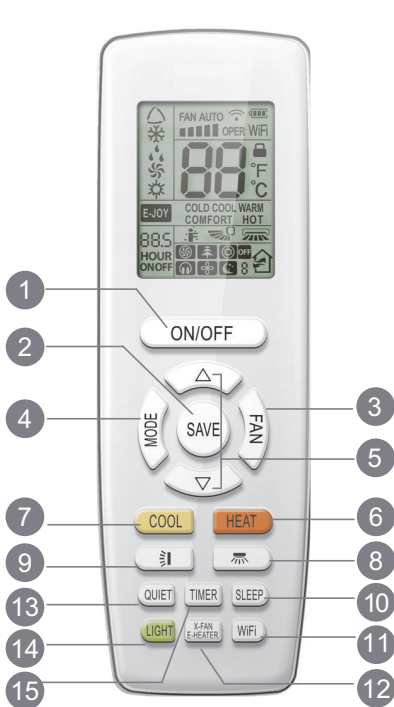

## 6.2 Remote Control Operations

### Buttons on remote controller



- 1 ON/OFF button
- 2 SAVE button
- 3 FAN button
- 4 MODE button
- 5 ▲/ ▼ button
- 6 HEAT button
- 7 COOL button
- 8  button
- 9  button
- 10 SLEEP button
- 11 WiFi button
- 12 X-FAN/E-HEATER button
- 13 QUIET button
- 14 LIGHT button
- 15 TIMER button

### Introduction for icons on display screen

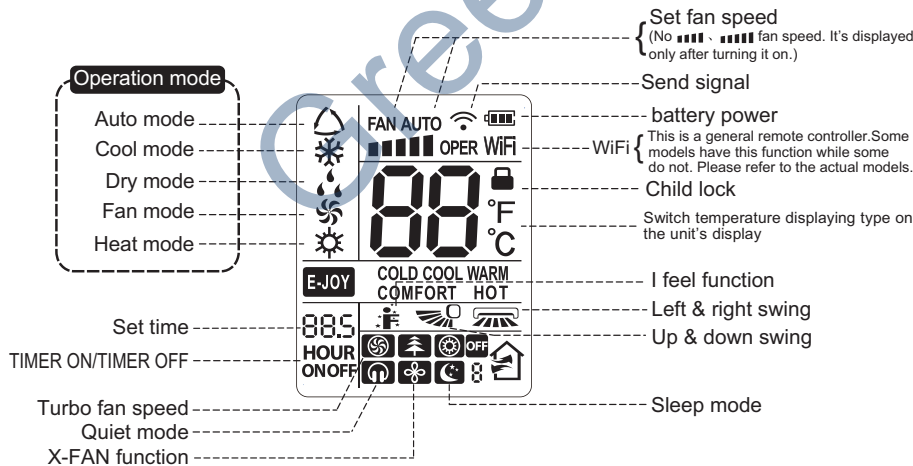

### Introduction for buttons on remote controller

**Note:**

- This is a general use remote controller, it could be used for the air conditioners with multifunction; For some function, which the model doesn't have, if press the corresponding button on the remote controller that the unit will keep the original running status.
- After putting through the power, the air conditioner will give out a sound. Operation indicator "⏻" is ON. After that, you can operate the air conditioner by using remote controller.
- Under on status, pressing the button on the remote controller, the signal icon "📶" on the display of remote controller will blink once and the air conditioner will give out a "di" sound, which means the signal has been sent to the air conditioner.

### 1 ON/OFF button

Press this button can turn on or turn off the air conditioner. After turning on the air conditioner, indoor unit will give out a sound.

### 2 SAVE button

Under cooling mode, press this button to start up or turn off energy-saving function. When energy-saving function is started up, "SE" will be shown on remote controller, and air conditioner will adjust the set temperature automatically according to ex-factory setting to reach to the best energy-saving effect. Press this button again to exit energy-saving function.

### 3 FAN button

Pressing this button can set fan speed circularly as: auto (AUTO), low(■), medium (■■), high(■■■), turbo(☞).



#### Note:

- Under AUTO speed, air conditioner will select proper fan speed automatically according to ex-factory setting.
- It's Low fan speed under Dry mode.
- Turbo cannot be set in FAN mode.

### 4 MODE button

Press this button to select your required operation mode.



- When selecting auto mode, air conditioner will operate automatically according to the sensed temperature. Set temperature can't be adjusted and will not be displayed as well. Press "FAN" button can adjust fan speed. Press "☞" / "☞" button can adjust fan blowing angle.
- After selecting cool mode, air conditioner will operate under cool mode. Cool indicator "❄" on indoor unit is ON. Press "▲" or "▼" button to adjust set temperature. Press "FAN" button to adjust fan speed. Press "☞" / "☞" button to adjust fan blowing angle.
- When selecting dry mode, the air conditioner operates at low speed under dry mode. Dry indicator "💧" on indoor unit is ON. Under dry mode, fan speed can't be adjusted. Press "☞" / "☞" button to adjust fan blowing angle.
- When selecting fan mode, the air conditioner will only blow fan, no cooling and no heating. Fan indicator "☞" on indoor unit is ON. Press "FAN" button to adjust fan speed. Press "☞" / "☞" button to adjust fan blowing angle.
- When selecting heating mode, the air conditioner operates under heat mode. Heat indicator "☀" on indoor unit is ON. Press "▲" or "▼" button to adjust set temperature. Press "FAN" button to adjust fan speed. Press "☞" / "☞" button to adjust fan blowing angle. (Cooling only unit won't receive heating mode signal. If setting heat mode with remote controller, press ON/OFF button can't start up the unit).

#### Note:

- For preventing cold air, after starting up heating mode, indoor unit will delay 1~5 minutes to blow air (actual delay time is depend on indoor ambient temperature).
- Set temperature range from remote controller: 16~30℃ (61-86°F); Fan speed: auto, low speed, medium speed, high speed, turbo speed.

### 5 ▲ / ▼ button

- Press "▲" or "▼" button once increase or decrease set temperature 1℃ (°F). Holding "▲" or "▼" button, 2s later, set temperature on remote controller will change quickly. On releasing button after setting is finished, temperature indicator on indoor unit will change accordingly. (Temperature can't be adjusted under auto mode)
- When setting TIMER ON, TIMER OFF, press "▲" or "▼" button to adjust time. (Refer to TIMER button for details)





### 6 Cool button

- Press this button, unit will operate in cool mode.



### 7 Heat button

- Press this button, unit will operate in heat mode.



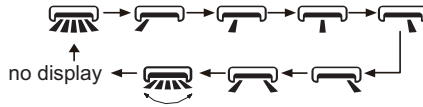

## 8 button

- Under simple swing mode, pres this button can turn on ("" icon is displayed) or turn off ("" icon is not displayed) the left&right swing function.
  - When the unit is turned off by remote controller, press "▲" button and "" button can switch between single swing mode and fixed-angle swing mode. "" on the remote controller will flash twice.
- Under fixed-angle swing mode, press this button and then left&right swing status will circulate as shown in the right figure:



- This remote controller is the general type remote controller. When remote controller receives the signal of "", swing status is same as ""; when remote controller receives "", swing status is same as left&right swing OFF.

## 9 button

- Under simple swing mode, pres this button can turn on ("" icon is displayed) lor turn off ("" icon is not displayed) the up&down swing function.
- When the unit is turned off by remote controller, press "▲" button and "" button can switch between single swing mode and fixed-angle swing mode. "" on the remote controller will flash twice. Under fixed-angle swing mode, press this button and the up&down swing status will circulate as shown in the right figure:

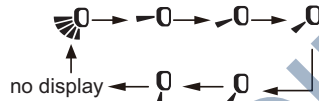

## 10 SLEEP button

Under COOL, or HEAT mode, press this button to start up sleep function. "☾" icon is displayed on remote controller. Press this button again to cancel sleep function and "☾" icon will disappear. After powered on, Sleep Off is defaulted. After the unit is turned off, the Sleep function is canceled. In this mode, the time of time can be adjusted. Under Fan, DRY and Auto modes, this function is not available.

## 11 WiFi button

Press "WiFi" button to turn on or turn off WiFi function. When WiFi function is turned on, the "WiFi" icon will be displayed on remote controller; Under status of remote controller off, press "MODE" and "WiFi" buttons simultaneously for 1s, WiFi module will restore to factory default setting.

- This function is only available for some models.

## 12 X-FAN/E-HEATER button

Pressing this button in COOL or DRY mode, the icon "" is displayed and the indoor fan will continue operation for a few minutes in order to dry the indoor unit even though you have turned off the unit. After energization, X-FAN OFF is defaulted. X-FAN is not available in AUTO, FAN or HEAT mode. This function indicates that moisture on evaporator of indoor unit will be blown after the unit is stopped to avoid mould.

- Having set X FAN function on: After turning off the unit by pressing ON/OFF button indoor fan will continue running for about a few minutes. at low speed. In this period, press X-FAN button to stop indoor fan directly.
- Having set X FAN function off: After turning off the unit by pressing ON/OFF button, the complete unit will be off directly.
- Only under cooling mode and dry mode, press this button can turn on (characters of "X-FAN" are displayed) or turn off (characters of "X-FAN" are not displayed) X-FAN function.
- Under heating mode, press this button and the E-HEATER status will changed circularly as below:

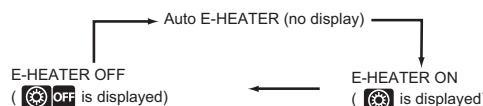



## 6.3 Introduction of Each Mode Function

### 1. Summary

Temperature parameter

- ◆ Indoor set temperature ( $T_{\text{preset}}$ )
- ◆ Indoor ambient temperature ( $T_{\text{amb.}}$ )
- ◆ Inner tube temperature of indoor evaporator ( $T_{\text{tube}}$ )

### 2. Introduction of basic mode function

Once the compressor is energized, there should be a minimum interval of 3 mins between two start-ups.

If the unit is with memory function and is off before power failure, the compressor can be restarted without an interval of 3 mins; if the unit is on before power failure, the compressor will be restarted with an interval of 3 mins.

Once compressor is started, it won't stop within 6 mins according to the change of room temp.

#### (1) Auto mode

##### ① Operation condition and process

Under auto mode, the system will automatically select operation mode (cooling, dry, heating and fan) according to indoor ambient temperature.

- ◆ When  $T_{\text{amb.}} > 26^{\circ}\text{C}$ , the system operates under cooling mode; Ex-factory set temperature is  $26^{\circ}\text{C}$ .
  - ◆ When  $20^{\circ}\text{C} \leq T_{\text{amb.}} \leq 26^{\circ}\text{C}$ , the system operates under drying mode; Ex-factory set temperature is  $24^{\circ}\text{C}$ .
  - ◆ Heat pump unit: when  $T_{\text{amb.}} < 20^{\circ}\text{C}$ , the system operates under heating mode; Ex-factory set temperature is  $20^{\circ}\text{C}$ .
  - ◆ Cooling only unit: when  $T_{\text{amb.}} < 20^{\circ}\text{C}$ , the system operates under fan mode; Ex-factory set temperature is  $20^{\circ}\text{C}$ .
- ② Protection function is same as that under cooling, drying and heating mode. (See function protection of this section)

#### (2) Cooling mode

##### ① Operation condition and process

- ◆ When  $T_{\text{amb.}} \geq T_{\text{set}} + 1^{\circ}\text{C}$ , the system operates under cooling mode. In this case, the compressor and the ODU fan motor operate, and the IDU fan motor operates at set speed.
- ◆ When  $T_{\text{set}} - 1^{\circ}\text{C} < T_{\text{amb.}} < T_{\text{set}} + 1^{\circ}\text{C}$ , the system will maintain its previous operation status.
- ◆ When  $T_{\text{amb.}} \leq T_{\text{set}} - 1^{\circ}\text{C}$ , the compressor and the ODU fan motor stop, while the IDU fan motor operates at set speed.

In cooling mode, the 4-way valve is de-energized (4-way valve is not available for cooling only unit). Temperature setting range is  $16 \sim 30^{\circ}\text{C}$ .

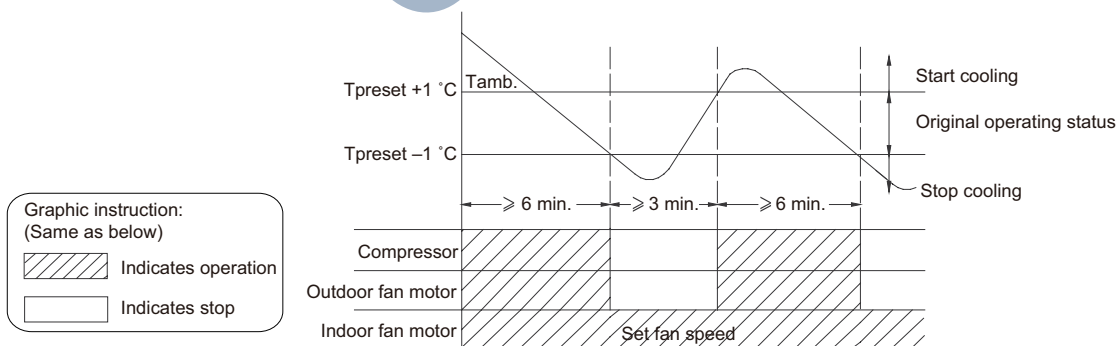

##### ② Protection function (See function protection of this section)

#### (3) Drying mode

##### ① Operation condition and process

- ◆ When  $T_{\text{amb.}} > T_{\text{set}} + 2^{\circ}\text{C}$ , the system starts drying and cooling. In this case, the compressor and the ODU fan motor operate, and the IDU fan motor operates at low speed.
- ◆ When  $T_{\text{set}} - 2^{\circ}\text{C} \leq T_{\text{amb.}} \leq T_{\text{set}} + 2^{\circ}\text{C}$ , the compressor and the ODU fan motor operate for 6 mins and stop for 4 mins in cycle; the IDU



### 3 Other control function introductions









#### (1) Swing function (the unit is with up&down swing and left&right swing)

##### a. Up&down swing control

① After energization, swing motor will firstly have the horizontal louver rotate anticlockwise to position O to close air outlet. If swing function has not been set after start-up of the unit, horizontal louver will turn clockwise to position D in heating mode, or turn clockwise to position L in other modes.

② If swing function is set when turning on the unit, the horizontal louver will swing between L and D.

Horizontal louver has 7 swing statuses:

- ◆ Stay at position L: control by remote controller: 
- ◆ Stay at position A: control by remote controller: 
- ◆ Stay at position B: control by remote controller: 
- ◆ Stay at position C: control by remote controller: 
- ◆ Stay at position D: control by remote controller: 
- ◆ Swing between L and D: control by remote controller:  ,  ,  , 
- ◆ Stop at any position between L and D (angles between L and D are equiangular), control by remote controller: OFF

③ When turning off the unit, horizontal louver will close at position O.









④ Swing action is valid only when swing command has been set and the IDU fan motor is operating.

##### b. Left&right swing control

① After energization, swing motor will firstly have the vertical louver rotate anticlockwise to position O to close air outlet. If swing function has not been set after start-up of the unit, vertical louver will turn clockwise to position D in heating mode, or turn clockwise to position L in other modes.

② If swing function is set when turning on the unit, the vertical louver will swing between L and D.

Vertical louver has 7 swing statuses:

- ◆ Stay at position L: control by remote controller: 
- ◆ Stay at position A: control by remote controller: 
- ◆ Stay at position B: control by remote controller: 
- ◆ Stay at position C: control by remote controller: 
- ◆ Stay at position D: control by remote controller: 
- ◆ Swing between L and D: control by remote controller:  ,  ,  , 
- ◆ Stop at any position between L and D (angles between L and D are equiangular), control by remote controller: OFF

③ When turning off the unit, vertical louver will close at position O.

④ Swing action is valid only when swing command has been set and the IDU fan motor is operating.

#### (2) Sleep function

◆ If start up sleep function under cooling or drying mode, the system will increase set temperature automatically within 3°C and then operate at increased temperature.

◆ If start up sleep function under heating mode, the system will decrease set temperature automatically within 3°C and then operate at decreased temperature.

#### (3) Turbo function

Turbo function can be set under cooling and heating modes (Turbo function is not available in auto, drying and fan mode). During operation of turbo function, the IDU fan motor operates at the highest fan speed.

#### (4) X-FAN function

X-FAN function can be set under cooling and drying modes (Turbo function is not available in auto, heating and fan mode). During operation of X-FAN function, the IDU fan motor will stop operation after operating for 10 mins at lowest fan speed when turning off the unit and then the system stops operation.

#### (5) Auxiliary heating function

When auxiliary heating function is set in heating mode: IDU fan motor operates and auxiliary electric heater operates; when ambient temperature has reached a certain degree, the auxiliary electric heater stops operation.

#### (6) Timer function

The controller has timer function. The precision of timer is 0.5 hour. 24 hours circulated timer can't be set.

Timer ON: Timer ON can be set at unit OFF. If selected ON time is reached, the unit will start to operate according to previous setting

Set this position as starting point O (0°)

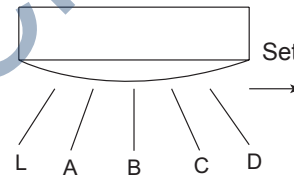
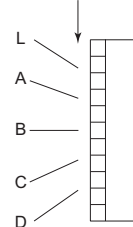

Set this position as starting point O (0°)



**(7) Indoor high temperature protection (applicable for heating and auto mode)**

When IDU fan motor is in turbo or high fan speed and  $T_{tube} \geq 56^{\circ}\text{C}$  , ODU fan motor stops operation; when  $T_{tube} \leq 49^{\circ}\text{C}$  , ODU fan motor starts operation again.

When IDU fan motor is in medium or low fan speed and  $T_{tube} \geq 52^{\circ}\text{C}$  , ODU fan motor stops operation; when  $T_{tube} \leq 46^{\circ}\text{C}$  , ODU fan motor starts operation again.

**(8) Temperature sensor malfunction protection (applicable in cooling, heating, drying fan or auto mode)**

- ① Malfunction of indoor ambient temperature sensor: indoor unit displays F1, which means indoor ambient temperature sensor is open-circuit or short-circuit, or its detection circuit element is broken.
- ② Malfunction of indoor evaporator temperature sensor: indoor unit displays F2, which means indoor evaporator temperature sensor is open-circuit or short-circuit, or its detection circuit element is broken.
- ③ Malfunction of outdoor ambient temperature sensor: indoor unit displays F3, which means outdoor ambient temperature sensor is open-circuit or short-circuit, or its detection circuit element is broken;
- ④ Malfunction of outdoor condenser temperature sensor: indoor unit displays F4, which means outdoor condenser temperature sensor is open-circuit or short-circuit, or its detection circuit element is broken;
- ⑤ Malfunction of outdoor discharge temperature sensor: indoor unit displays F5, which means outdoor discharge temperature sensor is open-circuit or short-circuit, or its detection circuit element is broken.

Gree Climat

# Part II : Installation and Maintenance

## 7. Notes for Installation and Maintenance

### Safety Precautions: Important!

Please read the safety precautions carefully before installation and maintenance.  
The following contents are very important for installation and maintenance.

Please follow the instructions below.

- The installation or maintenance must accord with the instructions.
- Comply with all national electrical codes and local electrical codes.
- Pay attention to the warnings and cautions in this manual.
- All electric work must be performed by a licensed technician according to local regulations and the instructions given in this manual.
- Be caution during installation and maintenance. Prohibit incorrect operation to prevent electric shock, casualty and other accidents.



### Warnings

#### Electrical Safety Precautions:

1. Cut off the power supply of air conditioner before checking and maintenance.
2. The air condition must apply specialized circuit and prohibit share the same circuit with other appliances.
3. The air conditioner should be installed in suitable location and ensure the power plug is touchable.
4. Make sure each wiring terminal is connected firmly during installation and maintenance.
5. Have the unit adequately grounded. The grounding wire can't be used for other purposes.
6. Must apply protective accessories such as protective boards, cable-cross loop and wire clip.
7. The live wire, neutral wire and grounding wire of power supply must be corresponding to the live wire, neutral wire and grounding wire of the air conditioner.
8. The power cord and power connection wires can't be pressed by hard objects.
9. If power cord or connection wire is broken, it must be replaced .

10. If the power cord or connection wire is not long enough, please get the specialized power cord or connection wire from the manufacture or distributor. Prohibit prolong the wire by yourself.

11. For the air conditioner without plug, an air switch must be installed in the circuit. The air switch should be all-pole parting and the contact parting distance should be more than 3mm.

12. Make sure all wires and pipes are connected properly and the valves are opened before energizing.

13. Check if there is electric leakage on the unit body. If yes, please eliminate the electric leakage.

14. Replace the fuse with a new one of the same specification if it is burnt down; don't replace it with a cooper wire or conducting wire.

15. If the unit is to be installed in a humid place, the circuit breaker must be installed.

#### Installation Safety Precautions:

1. Select the installation location according to the requirement of this manual.(See the requirements in installation part)
2. Handle unit transportation with care; the unit should not be carried by only one person if it is more than 20kg.
3. When installing the indoor unit and outdoor unit, a sufficient fixing bolt must be installed; make sure the installation support is firm.
4. Ware safety belt if the height of working is above 2m.
5. Use equipped components or appointed components during installation.
6. Make sure no foreign objects are left in the unit after finishing installation.

#### Refrigerant Safety Precautions:

1. Avoid contact between refrigerant and fire as it generates poisonous gas; Prohibit prolong the connection pipe by welding.
2. Apply specified refrigerant only. Never have it mixed with any other refrigerant. Never have air remain in the refrigerant line as it may lead to rupture or other hazards.
3. Make sure no refrigerant gas is leaking out when installation is completed.
4. If there is refrigerant leakage, please take sufficient measure to minimize the density of refrigerant.
5. Never touch the refrigerant piping or compressor without wearing glove to avoid scald or frostbite.

Improper installation may lead to fire hazard, explosion, electric shock or injury.



## Main Tools for Installation and Maintenance

<p>1. Measuring tape</p> 	<p>2. Screw driver</p> 	<p>3. Impact drill, drill head, electric drill</p> 
<p>4. Electroprobe</p> 	<p>5. Universal meter</p> 	<p>6. Torque wrench, open-end wrench, inner hexagon spanner</p> 
<p>7. Electronic leakage detector</p> 	<p>8. Vacuum pump</p> 	<p>9. Pressure meter</p> 
<p>10. Pipe pliers, pipe cutter</p> 	<p>11. Pipe expander, pipe bender</p> 	<p>12. Soldering appliance, refrigerant container</p> 



## Installation procedures

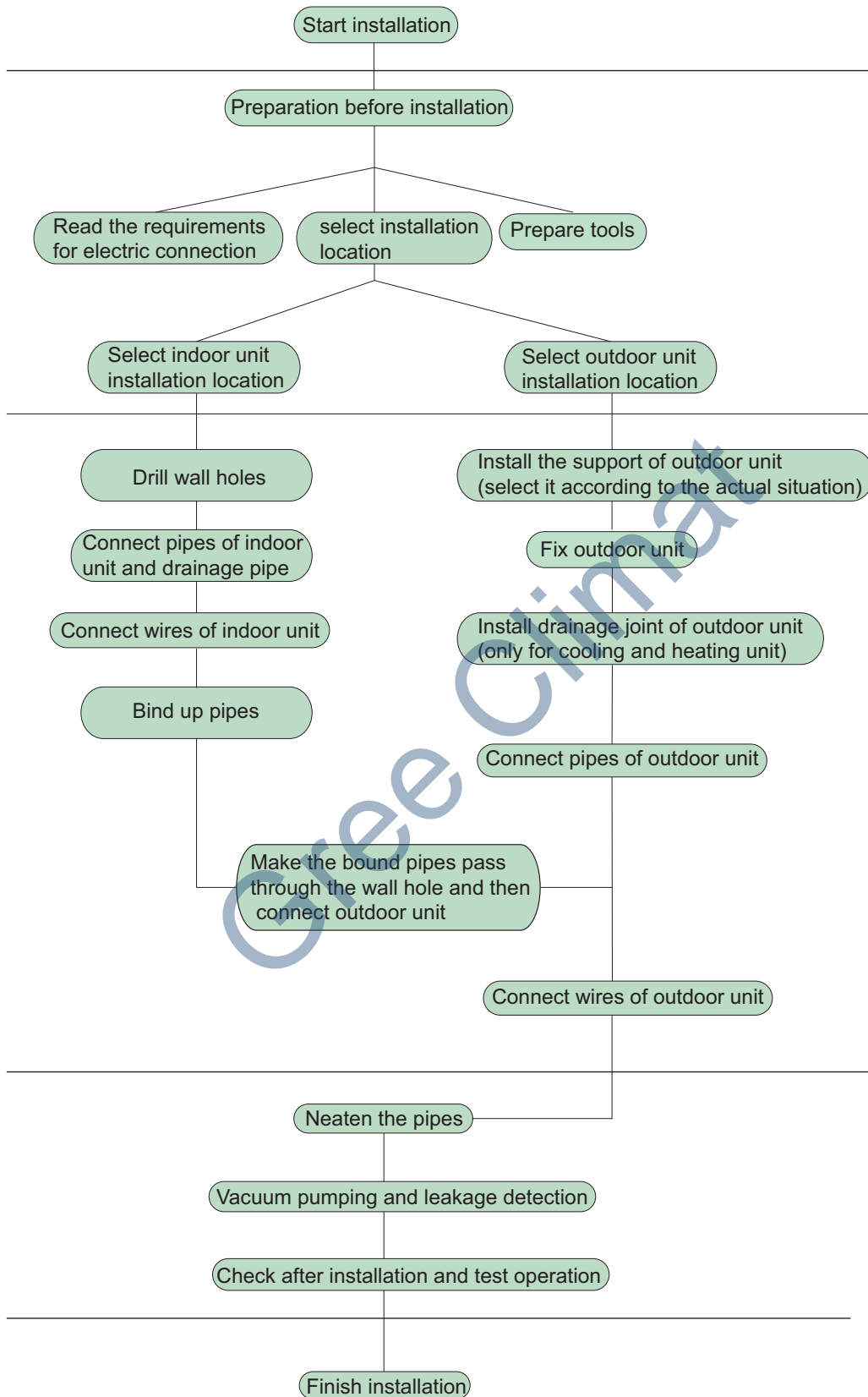

Note: this flow is only for reference; please find the more detailed installation steps in this section.

## 8.2 Installation Parts-checking

No.	Name	No.	Name
1	Indoor unit	7	Sealing gum
2	Outdoor unit	8	Wrapping tape
3	Connection pipe	9	Support of outdoor unit
4	Drainage pipe	10	Fixing screw
5	Connecting cable(power cord)	11	Drainage plug(cooling and heating unit)
6	Wall pipe	12	Owner's manual, remote controller

### ⚠ Note:

1. Please contact the local agent for installation.
2. Don't use unqualified power cord.

## 8.3 Selection of Installation Location

### Basic Requirement:

Installing the unit in the following places may cause malfunction. If it is unavoidable, please consult the local dealer:

1. The place with strong heat sources, vapors, flammable or explosive gas, or volatile objects spread in the air.
2. The place with high-frequency devices (such as welding machine, medical equipment).
3. The place near coast area.
4. The place with oil or fumes in the air.
5. The place with sulfureted gas.
6. Other places with special circumstances.

### Indoor Unit:

1. Avoid installing the indoor unit in a place where generated or leaked inflammable gas will stay.
2. Avoid installing the indoor unit in a moist place or in a place where oil may be splashed on the unit.
3. Select a location where outlet air may reach each corner of the room.
4. Select a location where connection pipe can be led to outdoor conveniently.
5. Select a location where air inlet and outlet won't be blocked.
6. Select a location with least affection of outdoor air.
7. Select a location with firm and flat floor.
8. Retain sufficient space for maintenance and installation.
9. Ensure the installation meets the requirement of installation dimension diagram.
10. Keep it away from fluorescent lamp.

### Outdoor Unit:

1. Select a location where the noise and outflow air emitted by the outdoor unit will not affect neighborhood.
2. The location should be well ventilated and dry, in which the outdoor unit won't be exposed directly to sunlight or strong wind.
3. The location should be able to withstand the weight of outdoor unit.
4. Make sure that the installation follows the requirement of installation dimension diagram.
5. Select a location which is out of reach for children and far away from animals or plants. If it is unavoidable, please add fence for safety purpose.
6. The height difference between indoor unit and outdoor unit should be within 5m. The length of connection pipe should be within 10m.

## 8.4 Requirements for electric connection

### ⚠ Safety Precaution:

1. Must follow the electric safety regulations when installing the unit.
2. If the supply cord is damaged, it must be replaced by the manufacturer or its service agent or a similarly qualified person in order to avoid a hazard.
3. According to the local safety regulations, use qualified power supply circuit and air switch.
4. A air switch having a contact separation of at least 3mm in all poles should be fixed in fixed wiring.
5. The appliance shall be installed in accordance with national wiring regulation.
6. The air switch must have the functions of magnetic tripping and heat tripping in order to prevent short circuit or overload. Please install the air switch with suitable capacity according to the sheet below.
7. Make sure the power supply matches with the requirement of air conditioner. Unstable power supply or incorrect wiring may result in electric shock, fire hazard or malfunction. Please install proper power supply cables before using the air conditioner.
8. Properly connect the live wire, neutral wire and grounding wire of power socket.
9. Be sure to cut off the power supply before proceeding any work related to electric safety.
10. Do not put through the power before finishing installation.
11. To be in compliance with EN 61000-3-11, impedance value of power-supply system connected to product must be less than or equal to the allowable maximum value of  $|Z_{sys}|$  in the following sheet:

models	max $ Z_{sys} $ unit:ohms
GVA24AL-K3NNC7A	0.036
GVA48AL-M3NNC7A	0.082
GVA55AL-M3NNC7A	0.079

Before connecting the product to public power network, please consult your local power supply authority to ensure that the power network has met the above requirements.

No requirement for the unlisted product's impedance value of power-supply system.

### ⚠ Grounding Requirement:

1. The air conditioner is first class electric appliance. It must be properly grounded with specialized grounding device by a professional. Please make sure it is always grounded effectively, otherwise it may cause electric shock.
2. The yellow-green wire in air conditioner is grounding wire, which can't be used for other purposes.
3. The grounding resistance should comply with national electric safety regulations.
4. Including an air switch with suitable capacity, please note the following table. Air switch should be included magnet buckle and heating buckle function, it can protect the circuit-short and overload. (Caution: please do not use the fuse only for protect the circuit)

Model	Capacity of air switch
24/48/55K	25A

## 8.5 Installation of Indoor Unit

### Step one: choosing installation location

Recommend the installation location to the client and then confirm it with the client.

### Step two: open piping hole

1. Choose the position of piping hole according to the direction of outlet pipe.

2. Open a piping hole with the diameter of  $\Phi 70\text{mm}$  on the selected outlet pipe position. In order to drain smoothly, slant the piping hole on the wall slightly downward to the outdoor side with the gradient of  $5\text{-}10^\circ$ . (As show in Fig.1)

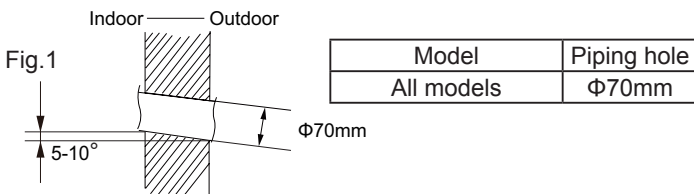

### ⚠ Note:

1. Pay attention to dust prevention and take relevant safety measures when opening the hole.
2. The plastic expansion particles are not provided and should be bought locally.

### Step three: outlet pipe

1. The pipe can be led out in the direction of left, right or rear. (As show in Fig.2)
2. After confirming the direction of outlet pipe, loosen the screws at the upper and lower adjusting baffle to let the connection pipe/drain pipe connects the indoor unit. (As show in Fig.3)

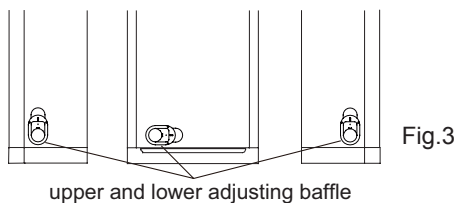
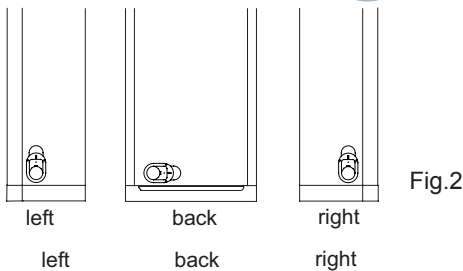

### Step four: connect the pipe of indoor unit

1. Take out the left and right screw cover and then remove the screws on air-inlet panel to remove the panel. (As show in Fig.4)
2. Aim the pipe joint at the corresponding bellmouth. (As show in Fig.5)

3. Pretightening the union nut with hand.
4. Adjust the torque force by referring to the following sheet. Place the open-end wrench on the pipe joint and place the torque wrench on the union nut. Tighten the union nut with torque wrench. (As show in Fig.6)
5. Wrap the indoor pipe and joint of connection pipe with insulating pipe, and then wrap it with tape. (As show in Fig.7)

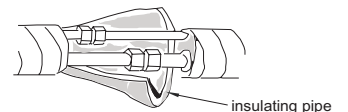
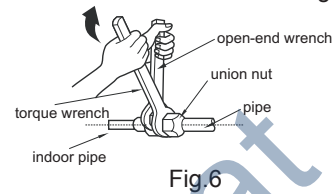
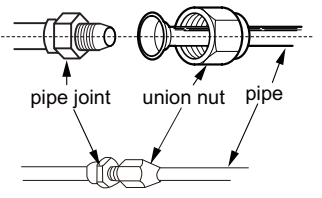
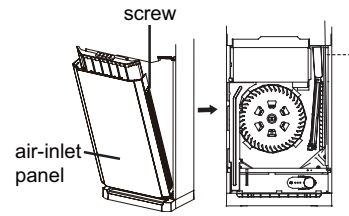

Refer to the following table for wrench moment of force:

Hex nut diameter(mm)	Tightening torque(N·m)
$\Phi 6$	15~20
$\Phi 9.52$	30~40
$\Phi 12$	45~55
$\Phi 16$	60~65
$\Phi 19$	70~75

### Step five: install drain hose

1. Connect the drain hose to the outlet pipe of indoor unit. (As show in Fig.8)
2. Bind the joint with tape. (As show in Fig.8)
3. Add insulating pipe in the indoor drain hose in order to prevent condensation. (As show in Fig.10)

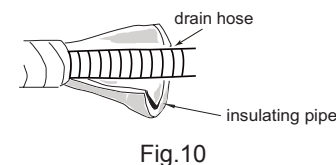
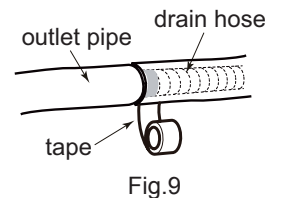
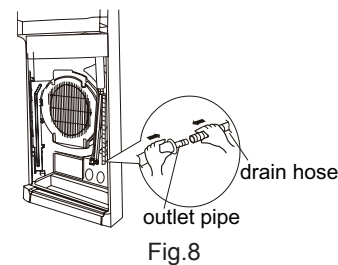

### Step six: connect wire of indoor unit

1. Make the power connection wire go through the cable-cross hole of indoor unit (As show in Fig.11)

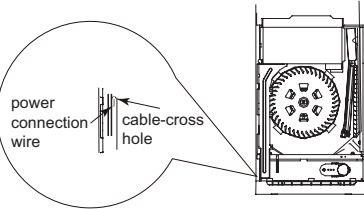
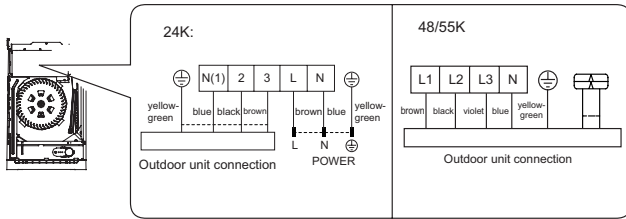

Fig.11

2. Remove the wire clip; connect the power connection wire to the wiring terminal according to the color; tighten the screw and then fix the power supply wire, power connection wire with wire clip. (As show in Fig.12)

Fig.12



3. Adjust the position of upper and lower adjusting baffle; clamp the connection pipe and drain pipe as firm as possible.  
4. Tighten the screws.

**⚠ Note:**

All wires of indoor unit and outdoor unit should be connected by a professional.

- 1.If the length of power connection wire is insufficient, please contact the supplier for a new one. Avoid extending the wire by yourself.
- 2.For the air conditioner with plug, the plug should be reachable after finishing installation.
- 3.For the air conditioner without plug, an air switch must be installed in the line. The air switch should be all-pole parting and the contact parting distance should be more than 3mm.

**Step seven: bind up pipe**

1. Bind up the connection pipe, power cord and drain hose with the band. (As show in Fig.13)
- 2.Reserve a certain length of drain hose and power cord for installation when binding to a certain degree, separate the indoor power and then separate the drain hose. (As show in Fig.14)
3. Bind them evenly.
4. The liquid pipe and gas pipe should be bound separately at the end.

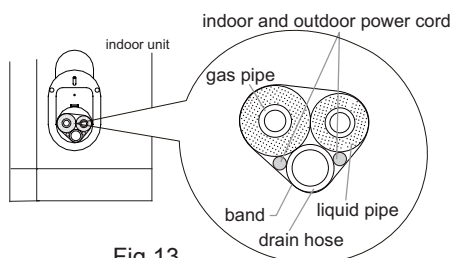

Fig.13

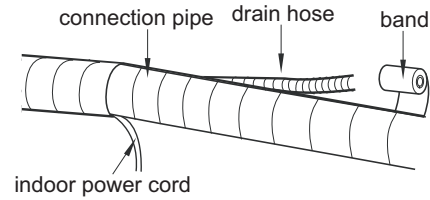

Fig.14

**⚠ Note:**

- 1.The power cord and control wire can't be crossed or winding.
- 2.The drain hose should be bound at the bottom.

**Step Eight: place the indoor unit**

- 1.Put the bound pipes in the wall pipe and then make them pass through the wall hole.
2. Stuff the gap between pipes and wall hole with sealing gum. (As show in Fig.15)
3. Fix the wall pipe.
- 4.Check if the indoor unit is installed firmly.

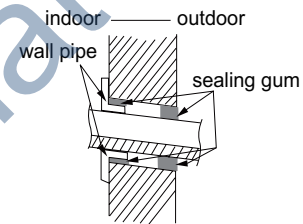

Fig.15

**⚠ Note:**

Do not bend the drain hose too excessively in order to prevent blocking.

**8.6 Installation of Outdoor Unit**

**1. Fix the Support of Outdoor Unit(select it according to the actual installation situation)**

- (1) Select installation location according to the house structure.
- (2) Fix the support of outdoor unit on the selected location with expansion screws.

**⚠ Note:**

- (1) Take sufficient protective measures when installing the outdoor unit.
- (2) Make sure the support can withstand at least four times the unit weight.
- (3) The outdoor unit should be installed at least 3cm above the floor in order to install drain joint. (As show in Fig.18)
- (4) For the unit with cooling capacity of 2300W~5000W, 6 expansion screws are needed; for the unit with cooling capacity of 6000W~8000W, 8 expansion screws are needed; for the unit with cooling capacity of 10000W~16000W, 10 expansion screws are needed.

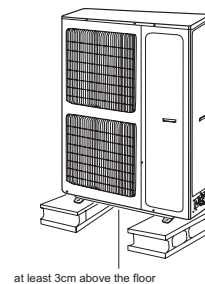

Fig.18

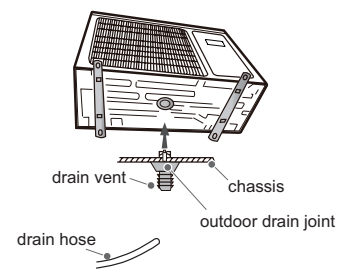

Fig.19

## 2. Install Drain Joint(Only for cooling and heating unit)

- (1) Connect the outdoor drain joint into the hole on the chassis.
- (2) Connect the drain hose into the drain vent.  
(As show in Fig.19)

## 3. Fix Outdoor Unit

- (1) Place the outdoor unit on the support.
- (2) Fix the foot holes of outdoor unit with bolts.  
(As show in Fig.20)

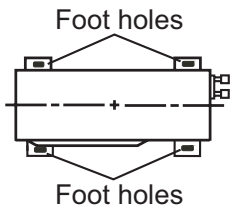

Fig.20

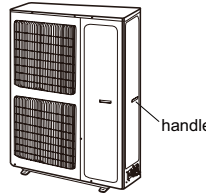

Fig.21

## 4. Connect Indoor and Outdoor Pipes

- (1) Remove the screw fixing the junction box cover of outdoor unit and then remove the cover.(As show in Fig.21)
- (2) Remove the screw cap of valve and aim the pipe joint at the bellmouth of pipe.(As show in Fig.22)

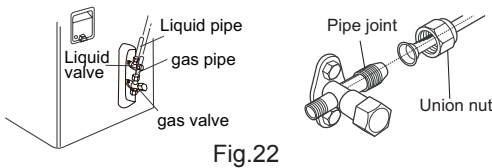

Fig.22

- (3) Pretightening the union nut with hand.
- (4) Tighten the union nut with torque wrench.

Refer to the following table for wrench moment of force:

Hex nut diameter(mm)	Tightening torque(N·m)
Φ6	15~20
Φ9.52	30~40
Φ12	45~55
Φ16	60~65
Φ19	70~75

## 5. Connect Outdoor Electric Wire

- (1) Remove the wire clip; connect the power connection wire and power wire to the wiring terminal according to the color; fix them with screws.(As show in Fig.23)

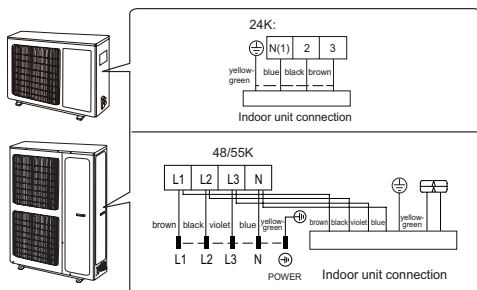

Fig.23

Note: the wiring board is for reference only, please refer to the actual one

- (2) Fix the power connection wire and signal control wire with wire clip (only for cooling and heating unit).

### ⚠ Note:

- (1) After tightening the screw, pull the power cord slightly to check if it is firm.
- (2) Never cut the power connection wire to prolong or shorten the distance.

## Step six: neaten the pipes

1. The pipes should be placed along the wall, bent reasonably and hidden possibly. Min. semidiameter of bending the pipe is 10cm.
2. If the outdoor unit is higher than the wall hole, you must set a U-shaped curve in the pipe before pipe goes into the room, in order to prevent rain from getting into the room. (As show in Fig.24)

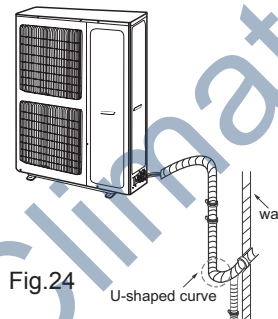

Fig.24

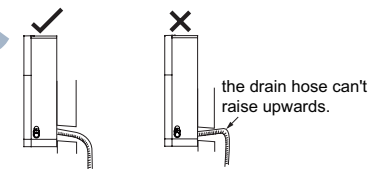

Fig.25

### ⚠ Note:

1. The through-wall height of drain hose shouldn't be higher than the outlet pipe hole of indoor unit.(As show in Fig.25)
2. Slant the drain hose slightly downwards. The drain hose can't be curved, raised and fluctuant, etc. (As show in Fig.26)
3. The water outlet can't be placed in water in order to drain smoothly.(As show in Fig.27)

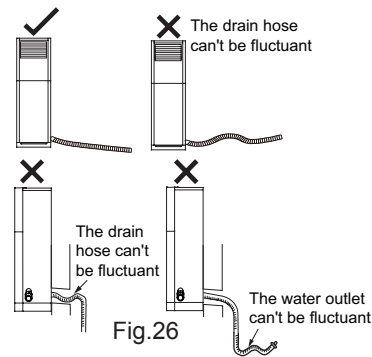

Fig.26

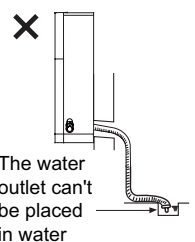

Fig.27

## 8.7 Vacuum Pumping and Leak Detection

### Use Vacuum Pump

1. Remove the valve caps on the liquid valve and gas valve and the nut of refrigerant charging vent.
2. Connect the charging hose of piezometer to the refrigerant charging vent of gas valve and then connect the other charging hose to the vacuum pump.
3. Open the piezometer completely and operate for 10-15min to check if the pressure of piezometer remains in -0.1MPa.
4. Close the vacuum pump and maintain this status for 1-2min to check if the pressure of piezometer remains in -0.1MPa. If the pressure decreases, there may be leakage.
5. Remove the piezometer, open the valve core of liquid valve and gas valve completely with inner hexagon spanner.
6. Tighten the screw caps of valves and refrigerant charging vent. (As show in Fig.26)

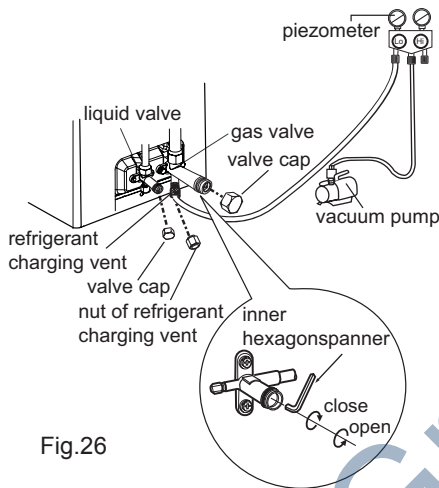

Fig.26

### Leakage Detection

1. With leakage detector:  
Check if there is leakage with leakage detector.
2. With soap water:  
If leakage detector is not available, please use soap water for leakage detection. Apply soap water at the suspected position and keep the soap water for more than 3min. If there are air bubbles coming out of this position, there's a leakage.

## 8.8 Check after Installation and Test Operation

### 1. Check After Installation

Check according to the following requirement after finishing installation.

NO.	Items to be checked	Possible malfunction
1	Has the unit been installed firmly?	The unit may drop, shake or emit noise.
2	Have you done the refrigerant leakage test?	It may cause insufficient cooling (heating) capacity.
3	Is heat insulation of pipeline sufficient?	It may cause condensation and water dripping.
4	Is water drained well?	It may cause condensation and water dripping.
5	Is the voltage of power supply according to the voltage marked on the nameplate?	It may cause malfunction or damage the parts.
6	Is electric wiring and pipeline installed correctly?	It may cause malfunction or damage the parts.
7	Is the unit grounded securely?	It may cause electric leakage.
8	Does the power cord follow the specification?	It may cause malfunction or damage the parts.
9	Is there any obstruction in air inlet and air outlet?	It may cause insufficient cooling (heating) capacity.
10	The dust and sundries caused during installation are removed?	It may cause malfunction or damaging the parts.
11	The gas valve and liquid valve of connection pipe are open completely?	It may cause insufficient cooling (heating) capacity.
12	Is the inlet and outlet of piping hole been covered?	It may cause insufficient cooling (heating) capacity or waster eletricity.

### 2. Test Operation

#### (1) Preparation of test operation

The client approves the air conditioner installation.

Specify the important notes for air conditioner to the client.

#### (2) Method of test operation

Put through the power, press ON/OFF button on the remote controller to start operation. Press MODE button to select AUTO, COOL, DRY, FAN and HEAT to check whether the operation is normal or not. If the ambient temperature is lower than 16 °C, the air conditioner can't start cooling.

## 9. Maintenance

### 9.1 Error Code List

No.	Malfunction Name	Display Method of Indoor Unit	A/C Status	Possible Causes	Maintenance measures
		Nixie tube display			
1	Indoor ambient temperature sensor is open/short-circuited	F1	The unit will stop operation as it reaches the temperature point. During cooling and drying operation, except IDU fan motor operates, other loads stop operation; During heating operation, the heating fan motor operates according to the conditions of blowing residual heat.	1. The wiring terminal between indoor ambient temperature sensor and maiboard is loosened or poorly contacted; 2. There's short circuit due to trip-over of the parts on maiboard; 3. Indoor ambient temperature sensor is damaged (Please check it by referring to the resistance table for temperature sensor); 4. Mainboard is broken.	Refer to Malfunction Detection Flowchart
2	Indoor evaporator temperature sensor is open/short-circuited	F2	The unit will stop operation as it reaches the temperature point. During cooling and drying operation, except IDU fan motor operates, other loads stop operation; During heating operation, the heating fan motor operates according to the conditions of blowing residual heat.	1. The wiring terminal between indoor evaporator temperature sensor and maiboard is loosened or poorly contacted; 2. There's short circuit due to trip-over of the parts on maiboard; 3. Indoor evaporator temperature sensor is damaged (Please check it by referring to the resistance table for temperature sensor); 4. Mainboard is broken.	Refer to Malfunction Detection Flowchart
3	Outdoor ambient temperature sensor is open/short-circuited	F3	The unit will stop operation as it reaches the temperature point. During cooling and drying operation, the compressor stops operation while IDU fan motor operates; During heating operation, the heating fan motor operates according to the conditions of blowing residual heat.	1. The wiring terminal between outdoor ambient temperature sensor and maiboard is loosened or poorly contacted; 2. There's short circuit due to trip-over of the parts on maiboard; 3. Outdoor ambient temperature sensor is damaged (Please check it by referring to the resistance table for temperature sensor); 4. Mainboard is broken.	Refer to Malfunction Detection Flowchart

4	Outdoor condenser temperature sensor is open/ short-circuited	F4	The unit will stop operation as it reaches the temperature point. During cooling and drying operation, the compressor stops operation while IDU fan motor operates; During heating operation, the heating fan motor operates according to the conditions of blowing residual heat.	<ol style="list-style-type: none"> <li>1. The wiring terminal between outdoor condenser temperature sensor and maiboard is loosened or poorly contacted;</li> <li>2. There's short circuit due to trip-over of the parts on maiboard;</li> <li>3. Outdoor condenser temperature sensor is damaged (Please check it by referring to the resistance table for temperature sensor);</li> <li>4. Mainboard is broken.</li> </ol>	Refer to Malfunction Detection Flowchart
5	Outdoor discharge temperature sensor is open/ short-circuited	F5	The unit will stop operation as it reaches the temperature point. During cooling and drying operation, the compressor stops operation while IDU fan motor operates; During heating operation, the heating fan motor operates according to the conditions of blowing residual heat.	<ol style="list-style-type: none"> <li>1. The wiring terminal between outdoor discharge temperature sensor and maiboard is loosened or poorly contacted;</li> <li>2. There's short circuit due to trip-over of the parts on maiboard;</li> <li>3. Outdoor discharge temperature sensor is damaged (Please check it by referring to the resistance table for temperature sensor);</li> <li>4. Mainboard is broken.</li> </ol>	Refer to Malfunction Detection Flowchart
6	High pressure protection	E1	During cooling and drying operation, except IDU fan motor operates, all loads stop operation. During heating operation, the complete unit stops and operation of remote controller or buttons is unavailable.	<ol style="list-style-type: none"> <li>1. The mainboard and the display board are not connected well;</li> <li>2. The OVC terminal on mainboard is not connected well with the high pressure switch on the complete unit;</li> <li>3. The wiring terminal between high pressure switch and maiboard is loosened or the high pressure switch is broken;</li> <li>4. Refrigerant is superabundant;</li> <li>5. Poor heat exchange (including blocked heat exchanger and bad radiating environment );</li> <li>6. Ambient temperature is too high; (if it is 3-phase unit, the high pressure protection may be caused by overcurrent protection due to this reason);</li> <li>7. The supply voltage is abnormal (if it is 3-phase unit, the high pressure protection may be caused by overcurrent protection due to this reason);</li> <li>8. The air intake and air discharge at indoor / outdoor heat exchanger are not smooth;</li> <li>9. Filter and heat exchange fins of indoor/ outdoor units are blocked;</li> <li>10. The pipeline is blocked;</li> <li>11. The gas valve and liquid valve for outdoor unit are not completely opened;</li> <li>12. The OVC input is at high level.</li> </ol>	Refer to Malfunction Detection Flowchart
7	Low pressure protection of compressor	E3	The complete unit stops.	<ol style="list-style-type: none"> <li>1. The mainboard and display board are not connected well;</li> <li>2. The LPP terminal on the mainboard is not connected well with the high pressure switch;</li> <li>3. The wiring of high pressure switch is loosened or high pressure switch is damaged.</li> <li>4. The refrigerant is insufficient;</li> <li>5. The LPP input is at high level.</li> </ol>	Refer to Malfunction Detection Flowchart

8	High discharge temperature protection of compressor	E4	During cooling and drying operation, compressor and ODU fan motor stop while IDU fan motor operates. During heating operation, all loads stop.	<ol style="list-style-type: none"> <li>1. The system is abnormal. (e.g.: blockage, etc)</li> <li>2. Abnormal rotation speed of outdoor motor (cooling );</li> <li>3. Abnormal outdoor air intake (cooling);</li> <li>4. System is normal, but the compressor discharge temperature sensor is broken or poorly contacted (Please check it by referring to the resistance table for temperature sensor).</li> </ol>	Refer to Malfunction Detection Flowchart
9	Overcurrent protection	E5	During cooling and drying operation, compressor and ODU fan motor stop while IDU fan motor operates. During heating operation, all loads stop.	<ol style="list-style-type: none"> <li>1. Unstable supply voltage. Normal fluctuation shall be within 10% of the rated voltage on the nameplate;</li> <li>2. Supply voltage is too low and load is too high;</li> <li>3. Measure the current of live wire on mainboard. If the current isn't higher than the overcurrent protection value, please check the mainboard;</li> <li>4. The indoor and outdoor heat exchangers are too dirty, or the air inlet and air outlet are blocked;</li> <li>5. The fan speed of fan motor is too low or the fan motor doesn't run;</li> <li>6. The compressor is not running normally. There is abnormal sound, oil leakage or the temperature of the shell is too high, etc;</li> <li>7. There's blockage in the system (filth blockage, ice blockage, greasy blockage or valve hasn't been opened completely) .</li> </ol>	Refer to Malfunction Detection Flowchart
10	Communication malfunction	E6	During cooling and drying operation, compressor and outdoor fan stop while indoor fan operates. During heating operation, all loads stop.	See 9.2 (Communication malfunction)	Refer to maintenance flowchart
11	Overload malfunction	E8	The entire unit stops.	<ol style="list-style-type: none"> <li>1. Indoor and outdoor heat exchanger is too dirty? Or air inlet/outlet is blocked?</li> <li>2. Fan motor is not working. Abnormal fan speed; fan speed is too low or the fan doesn't run.</li> <li>3. Compressor operates normally or not? Is there any abnormal noise or oil leak? Casing is too hot?</li> <li>4. System is blocked inside? (Dirt blockage? Ice blockage? Oil blockage? Y-valve is not fully open?)</li> <li>5. Main board temperature sensor detects wrongly.</li> </ol>	Refer to Malfunction Detection Flowchart
12	In defect of refrigerant	F0	The Dual-8 Code Display will show F0 and the complete unit stops.	<ol style="list-style-type: none"> <li>1. In defect of refrigerant;</li> <li>2. Indoor evaporator temperature sensor works abnormally;</li> <li>3. The unit has been plugged up somewhere.</li> </ol>	Refer to Malfunction Detection Flowchart



## 9.2 Procedure of Troubleshooting

### 1. Malfunction of Temperature Sensor (F1, F2, F3, F4, F5)

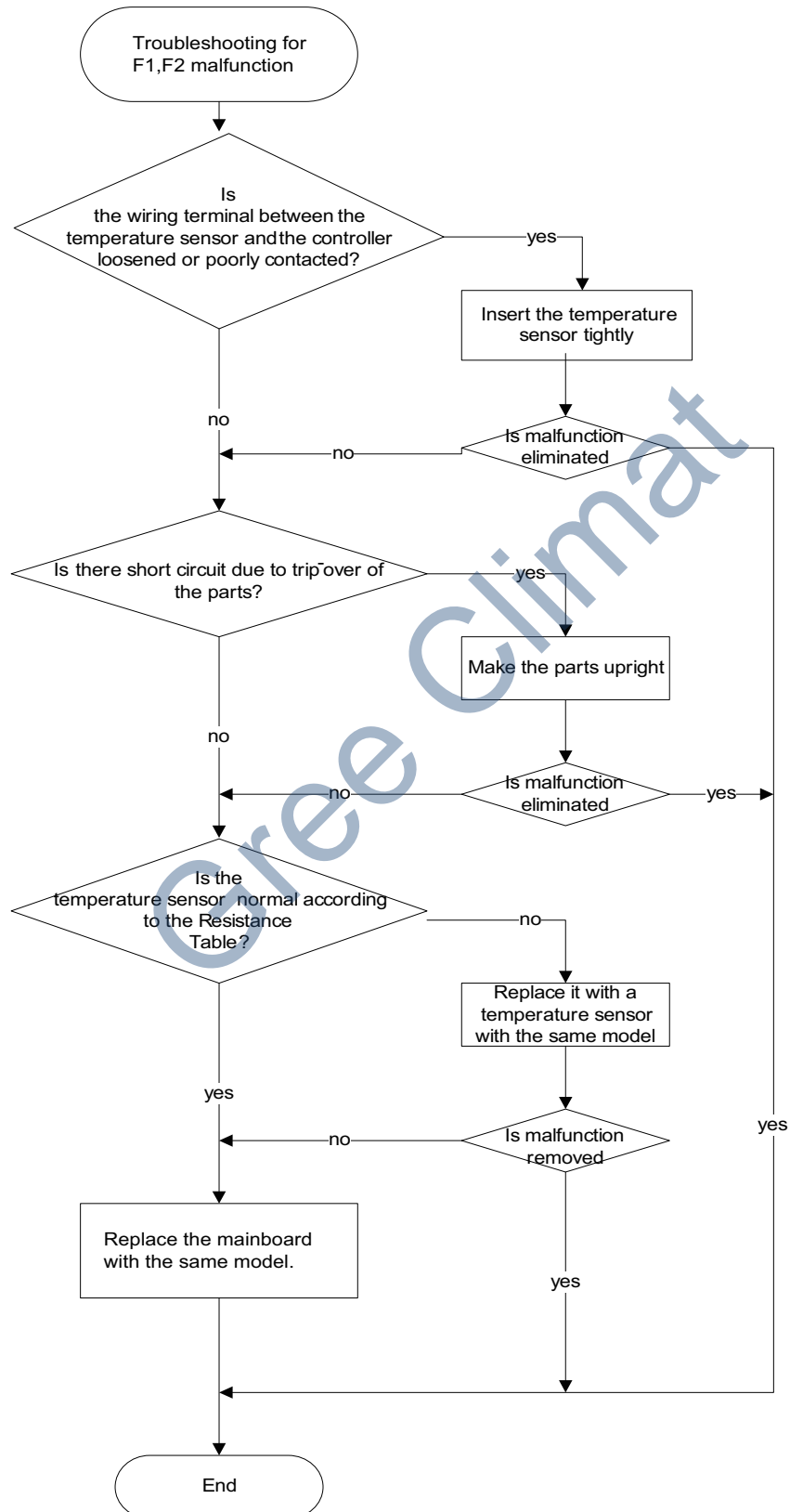

## 2. High pressure protection (E1)

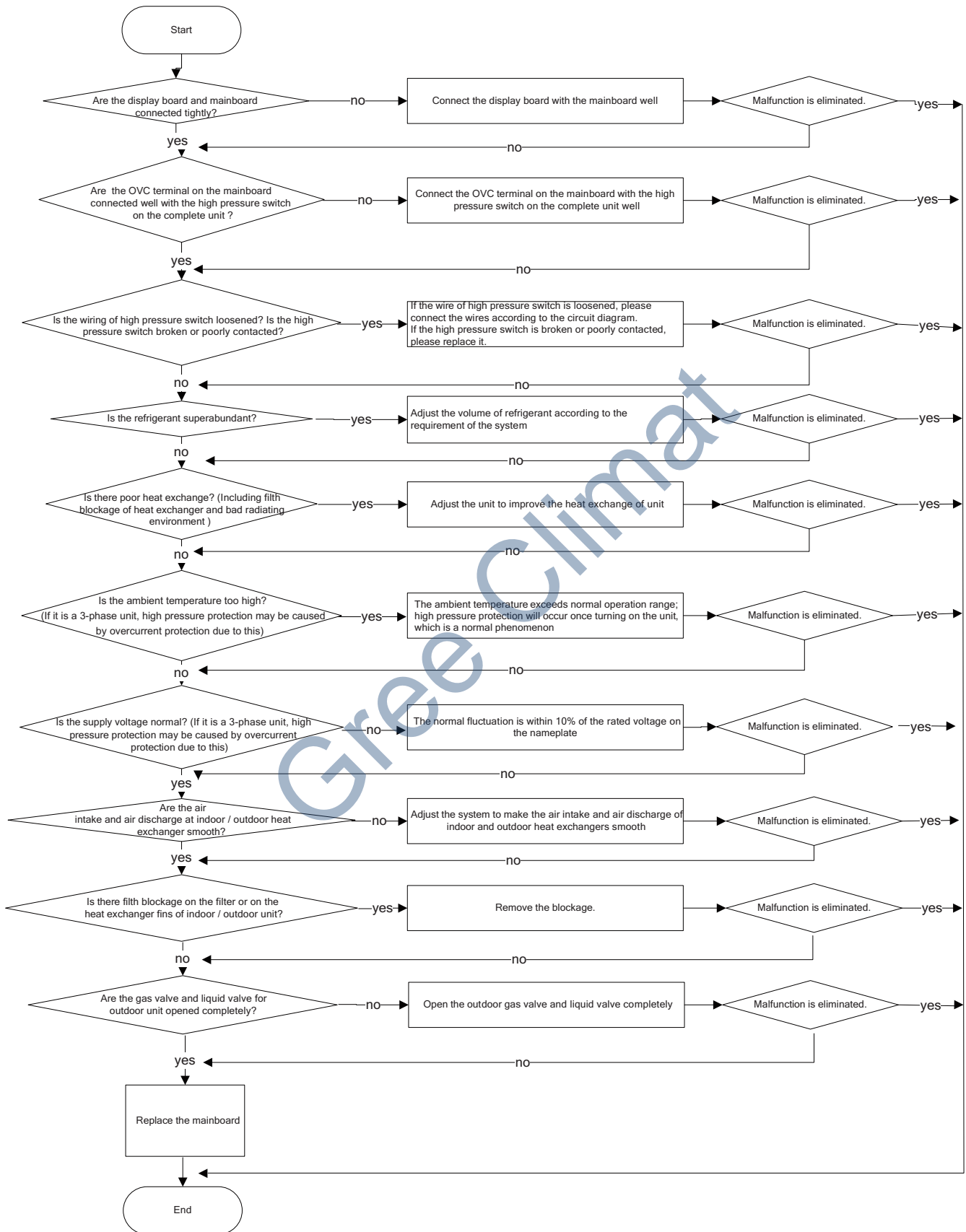

### 3. Compressor low pressure protection (E3)

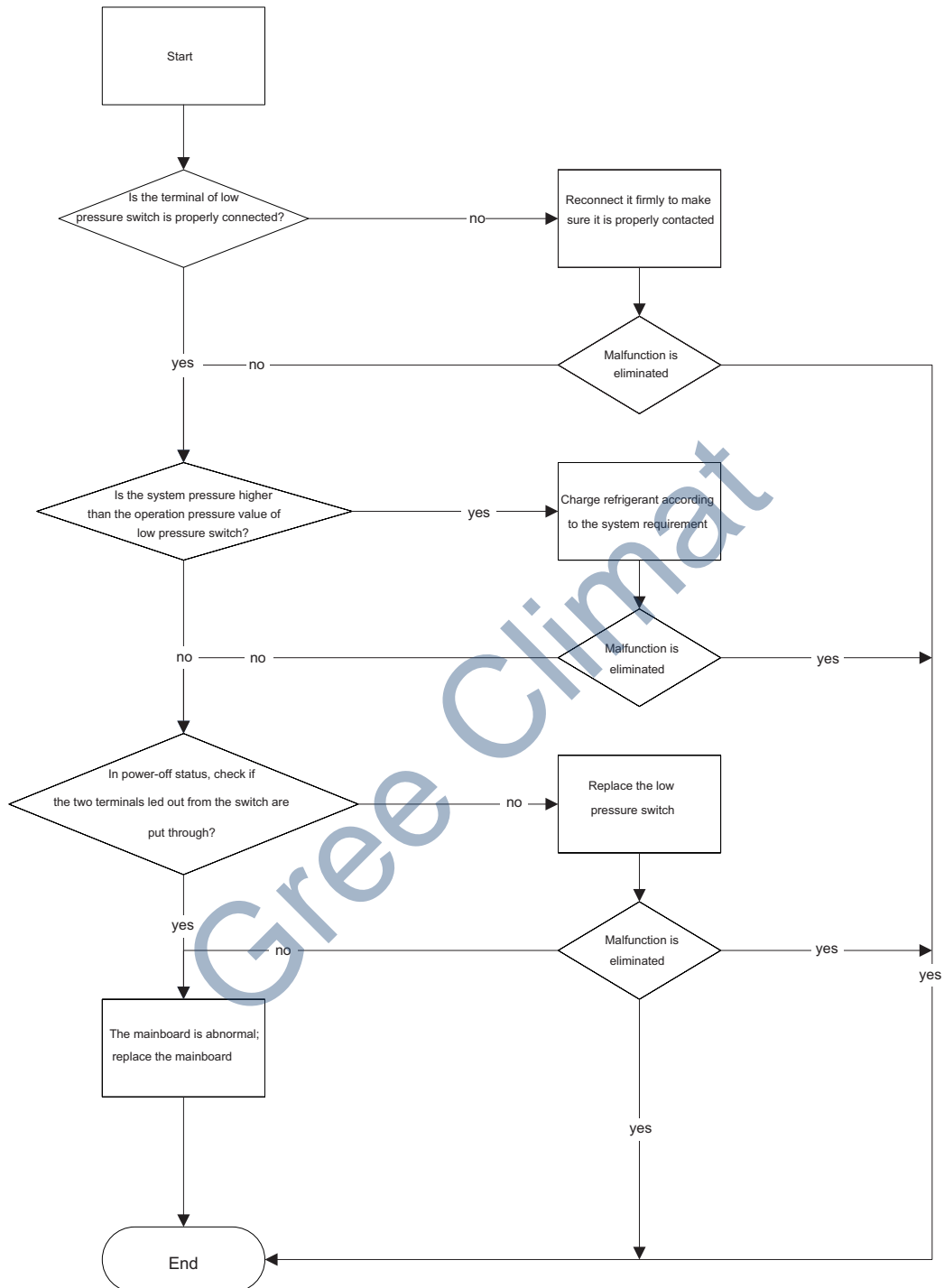



5. Malfunction of Overcurrent Protection (E5)

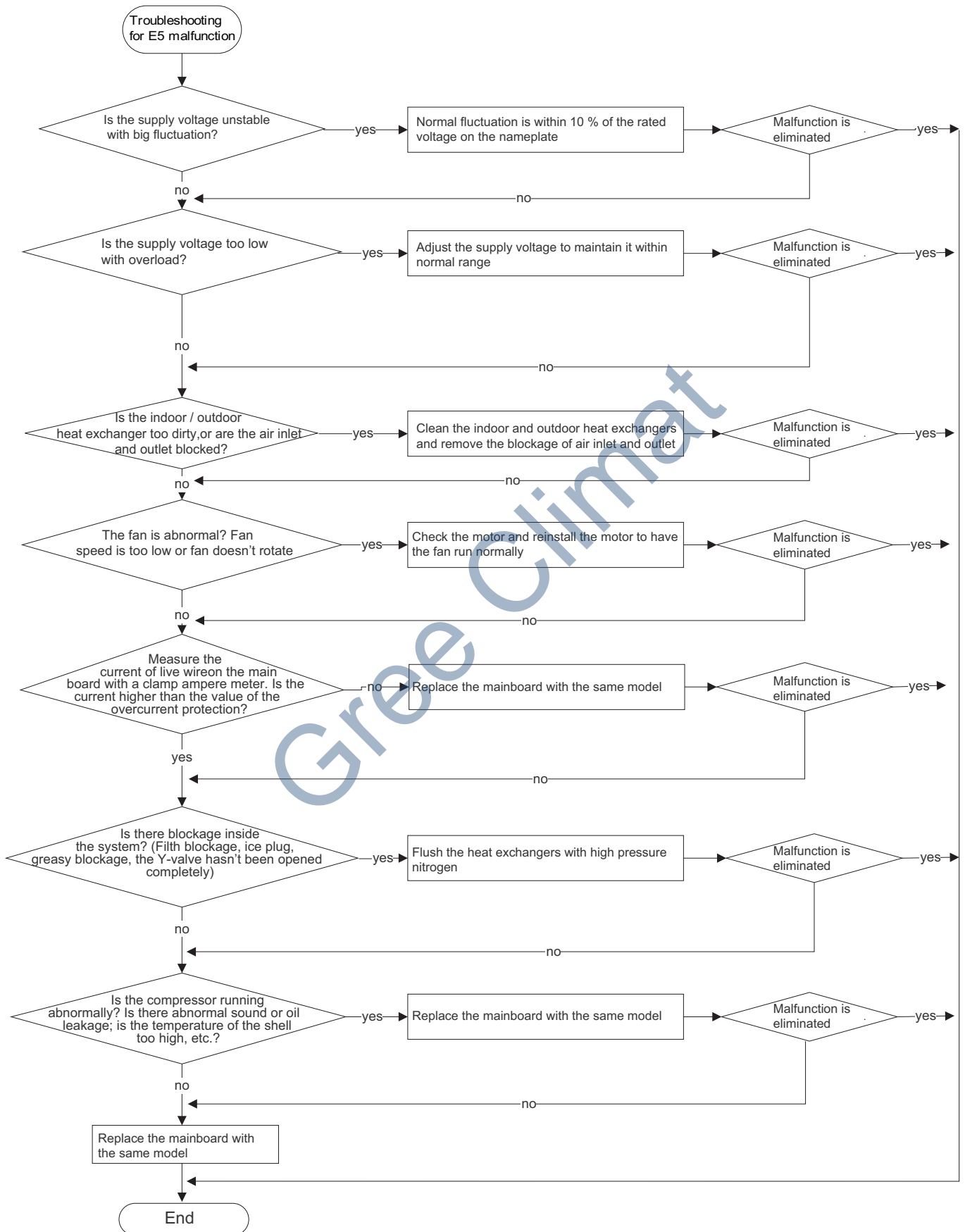



**7. High temperature and overload protection (AP1 below means control board of outdoor unit) E8**

Main detection points:

- If the outdoor ambient temperature is in normal range;
- If the indoor and outdoor fan are running normally;
- If the radiating environment of indoor and outdoor unit is good.

Malfunction diagnosis process:

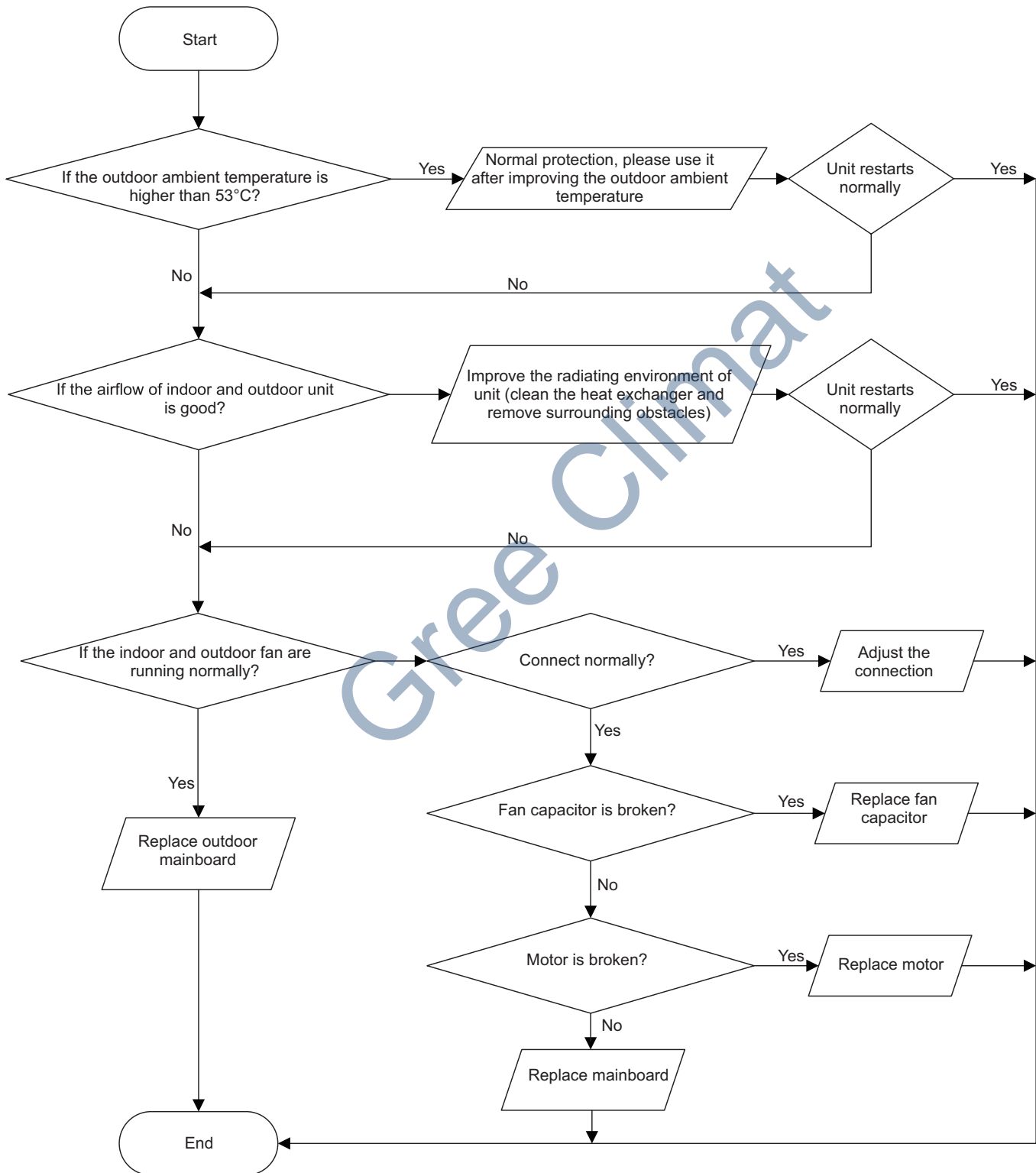

8 . Malfunction of Insufficient fluorine protection F0

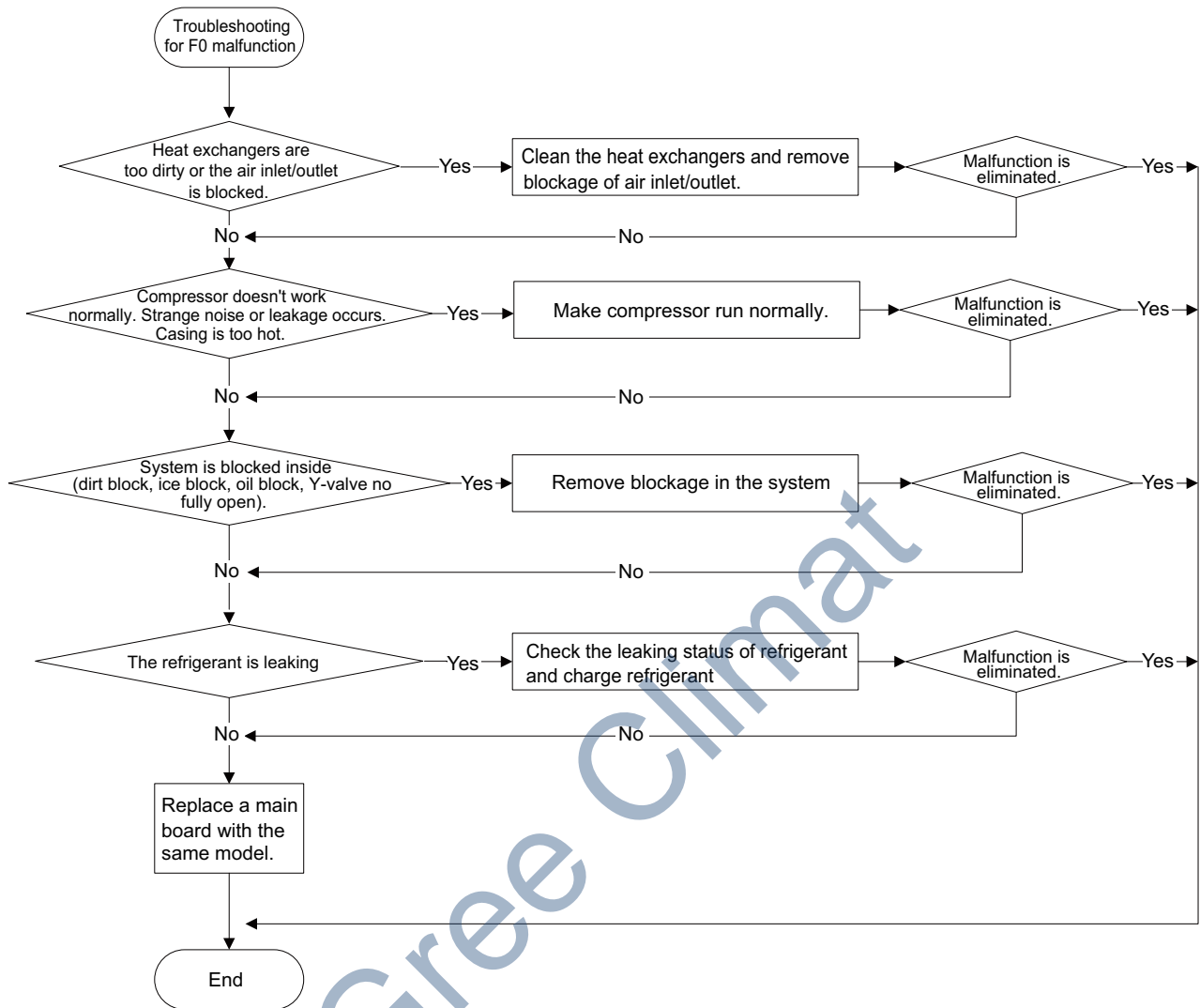

Gree Climat

Outdoor unit

1. Malfunction of Protection of Outdoor unit Jumper Cap C4

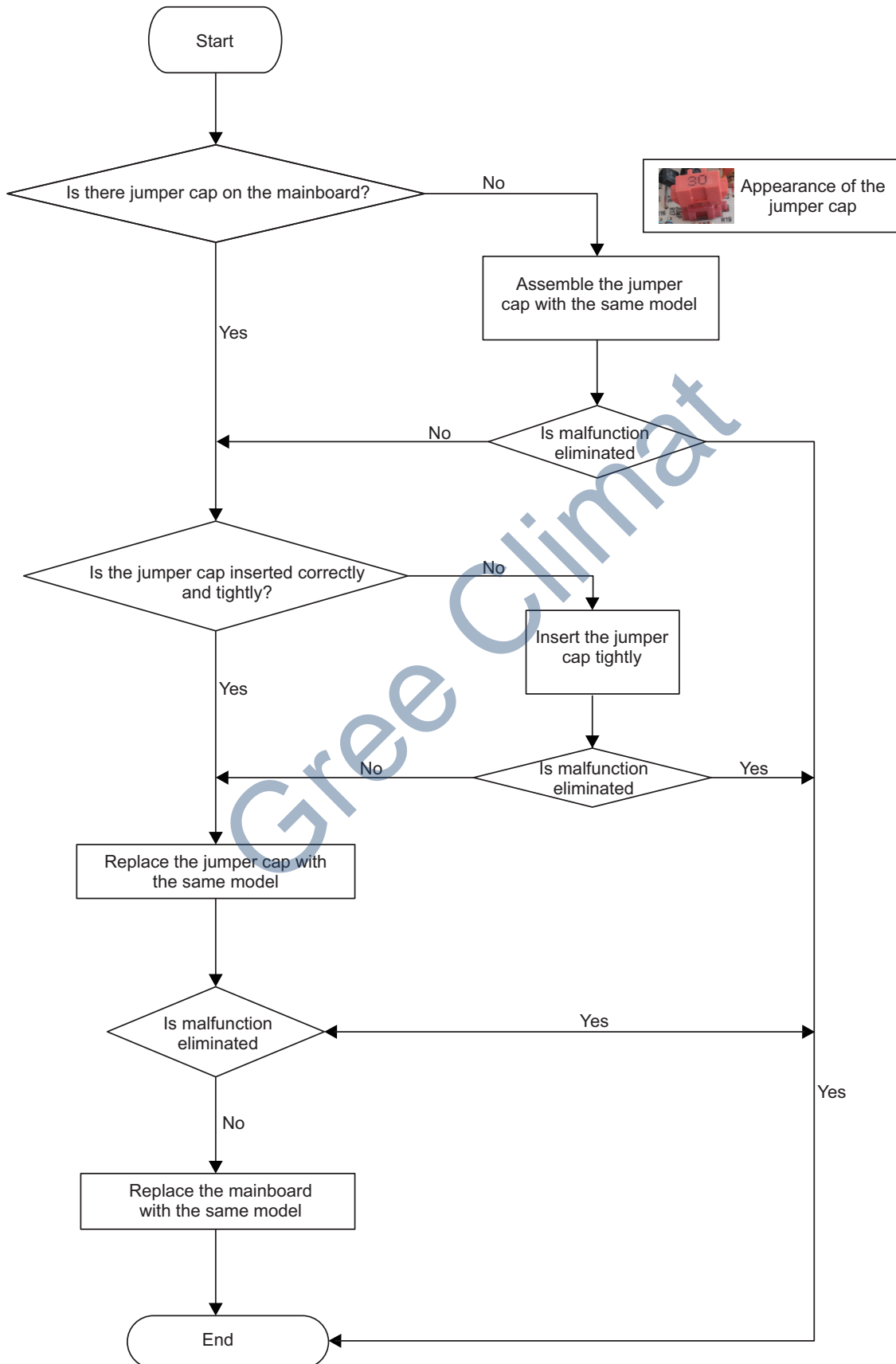

## 9.3 Maintenance Method for Normal Malfunction

### 1. Air Conditioner Can't be Started Up

Possible Causes	Discriminating Method (Air conditioner Status)	Troubleshooting
No power supply, or poor connection for power plug	After energization, operation indicator isn't bright and the buzzer can't give out sound	Confirm whether it's due to power failure. If yes, wait for power recovery. If not, check power supply circuit and make sure the power plug is connected well.
Wrong wire connection between indoor unit and outdoor unit, or poor connection for wiring terminals	Under normal power supply circumstances, operation indicator isn't bright after energization	Check the circuit according to circuit diagram and connect wires correctly. Make sure all wiring terminals are connected firmly
Electric leakage for air conditioner	After energization, room circuit breaker trips off at once	Make sure the air conditioner is grounded reliably Make sure wires of air conditioner is connected correctly Check the wiring inside air conditioner. Check whether the insulation layer of power cord is damaged; if yes, place the power cord.
Model selection for air switch is improper	After energization, air switch trips off	Select proper air switch
Malfunction of remote controller	After energization, operation indicator is bright, while no display on remote controller or buttons have no action.	Replace batteries for remote controller Repair or replace remote controller

### 2. Poor Cooling (Heating) for Air Conditioner

Possible Causes	Discriminating Method (Air conditioner Status)	Troubleshooting
Set temperature is improper	Observe the set temperature on remote controller	Adjust the set temperature
Rotation speed of the IDU fan motor is set too low	Small wind blow	Set the fan speed at high or medium
Filter of indoor unit is blocked	Check the filter to see it's blocked	Clean the filter
Installation position for indoor unit and outdoor unit is improper	Check whether the installation position is proper according to installation requirement for air conditioner	Adjust the installation position, and install the rainproof and sunproof for outdoor unit
Refrigerant is leaking	Discharged air temperature during cooling is higher than normal discharged wind temperature; Discharged air temperature during heating is lower than normal discharged wind temperature; Unit's pressure is much lower than regulated range	Find out the leakage causes and deal with it. Add refrigerant.
Malfunction of 4-way valve	Blow cold wind during heating	Replace the 4-way valve
Malfunction of capillary	Discharged air temperature during cooling is higher than normal discharged wind temperature; Discharged air temperature during heating is lower than normal discharged wind temperature; Unit's pressure is much lower than regulated range. If refrigerant isn't leaking, part of capillary is blocked	Replace the capillary
Flow volume of valve is insufficient	The pressure of valves is much lower than that stated in the specification	Open the valve completely
Malfunction of horizontal louver	Horizontal louver can't swing	Refer to point 3 of maintenance method for details
Malfunction of the IDU fan motor	The IDU fan motor can't operate	Refer to troubleshooting for H6 for maintenance method in details
Malfunction of the ODU fan motor	The ODU fan motor can't operate	Refer to point 4 of maintenance method for details
Malfunction of compressor	Compressor can't operate	Refer to point 5 of maintenance method for details

### 3. Horizontal Louver Can't Swing

Possible Causes	Discriminating Method (Air conditioner Status)	Troubleshooting
Wrong wire connection, or poor connection	Check the wiring status according to circuit diagram	Connect wires according to wiring diagram to make sure all wiring terminals are connected firmly
Stepping motor is damaged	Stepping motor can't operate	Repair or replace stepping motor
Main board is damaged	Others are all normal, while horizontal louver can't operate	Replace the main board with the same model

#### 4. ODU Fan Motor Can't Operate

Possible causes	Discriminating method (air conditioner status)	Troubleshooting
Wrong wire connection, or poor connection	Check the wiring status according to circuit diagram	Connect wires according to wiring diagram to make sure all wiring terminals are connected firmly
Capacity of the ODU fan motor is damaged	Measure the capacity of fan capacitor with an universal meter and find that the capacity is out of the deviation range indicated on the nameplate of fan capacitor.	Replace the capacity of fan
Power voltage is a little low or high	Use universal meter to measure the power supply voltage. The voltage is a little high or low	Suggest to equip with voltage regulator
Motor of outdoor unit is damaged	When unit is on, cooling/heating performance is bad and ODU compressor generates a lot of noise and heat.	Change compressor oil and refrigerant. If no better, replace the compressor with a new one

#### 5. Compressor Can't Operate

Possible causes	Discriminating method (air conditioner status)	Troubleshooting
Wrong wire connection, or poor connection	Check the wiring status according to circuit diagram	Connect wires according to wiring diagram to make sure all wiring terminals are connected firmly
Capacity of compressor is damaged	Measure the capacity of fan capacitor with an universal meter and find that the capacity is out of the deviation range indicated on the nameplate of fan capacitor.	Replace the compressor capacitor
Power voltage is a little low or high	Use universal meter to measure the power supply voltage. The voltage is a little high or low	Suggest to equip with voltage regulator
Coil of compressor is burnt out	Use universal meter to measure the resistance between compressor terminals and it's 0	Repair or replace compressor
Cylinder of compressor is blocked	Compressor can't operate	Repair or replace compressor

#### 6. Air Conditioner is Leaking

Possible causes	Discriminating method (air conditioner status)	Troubleshooting
Drain pipe is blocked	Water leaking from indoor unit	Eliminate the foreign objects inside the drain pipe
Drain pipe is broken	Water leaking from drain pipe	Replace drain pipe
Wrapping is not tight	Water leaking from the pipe connection place of indoor unit	Wrap it again and bundle it tightly

#### 7. Abnormal Sound and Vibration

Possible causes	Discriminating method (air conditioner status)	Troubleshooting
When turn on or turn off the unit, the panel and other parts will expand and there's abnormal sound	There's the sound of "PAPA"	Normal phenomenon. Abnormal sound will disappear after a few minutes.
When turn on or turn off the unit, there's abnormal sound due to flow of refrigerant inside air conditioner	Water-running sound can be heard	Normal phenomenon. Abnormal sound will disappear after a few minutes.
Foreign objects inside the indoor unit or there're parts touching together inside the indoor unit	There's abnormal sound fro indoor unit	Remove foreign objects. Adjust all parts' position of indoor unit, tighten screws and stick damping plaster between connected parts
Foreign objects inside the outdoor unit or there're parts touching together inside the outdoor unit	There's abnormal sound fro outdoor unit	Remove foreign objects. Adjust all parts' position of outdoor unit, tighten screws and stick damping plaster between connected parts
Short circuit inside the magnetic coil	During heating, the way valve has abnormal electromagnetic sound	Replace magnetic coil
Abnormal shake of compressor	Outdoor unit gives out abnormal sound	Adjust the support foot mat of compressor, tighten the bolts
Abnormal sound inside the compressor	Abnormal sound inside the compressor	If add too much refrigerant during maintenance, please reduce refrigerant properly. Replace compressor for other circumstances.

# 10. Exploded View and Parts List

## 10.1 Indoor Unit

GVA24AL-K3NNC7A/I

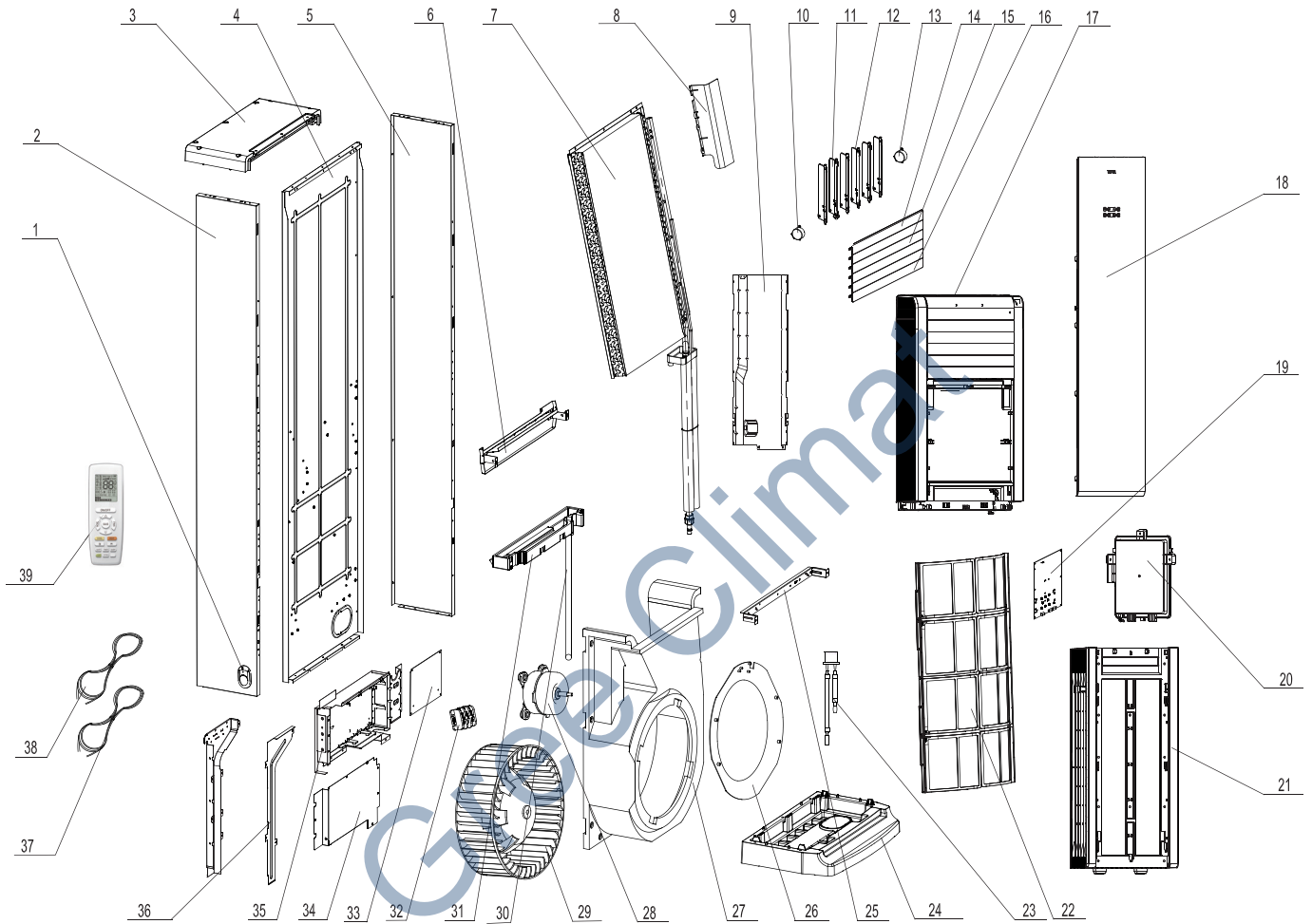

The component picture is only for reference; please refer to the actual product.

NO.	Description	Part Code	Qty
		GVA24AL-K3NNC7A/I	
Product Code		CG156N00200	
1	Baffle Plate	2611454401	1
2	Left Side Plate Sub-Assy	00013100003	1
3	Top Cover Sub-Assy	20906900008	1
4	Rear Plate Sub-Assy	01304364	1
5	Right Side Plate Sub-Assy	00013000005	1
6	Breakwater Sub-Assy	01364069P	1
7	Evaporator Assy	01100100218	1
8	Protection Cover	20124112	1
9	Air Guard Sub-Assy	00008800006	1
10	SteppingMotor	1521210104	1
11	Air Louver 1	10514120	1
12	Air Louver 2	10514121	1
13	Stepping Motor	15214211	1
14	Guide Louver 1	10514167	3
15	Guide Louver 2	1054420303	1
16	Guide Louver 3	1056420503	1
17	Air Outlet Panel Assy	00801400056	1
18	Front Door Plate Sub-assy	000055000028	1
19	Display Board	300001000198	1
20	Display Sub-Assy	000057000041	1
21	Air Intake Panel Assy	0000410001901	1
22	Filter Sub-Assy	1112423502/1112423401	1
23	Temperature Sensor	3900013711	1
24	Chassis	22224474	1
25	Propeller HousingPress Plate	01364215	6
26	Diversion Circle	10374006	1
27	Propeller Housing Sub-assy	12104226	1
28	Fan Motor	1501420208	1
29	Centrifugal Fan	10314001	1
30	Drainage Pipe Sub-assy	0523543401	5
31	Water Tray Sub-Assy	209041060005	6
32	Terminal Board	420001000004	1
33	Main Board	300002000697	1
34	Electric Box Cover Sub-Assy	01404922	1
35	Electric Box Assy	100002003737	1
36	Cover of pass	01254012	2
37	Connecting Cable	400204058	1
38	Power Cord	4002028801	1
39	Remote Controller	305001000125	1

Above data is subject to change without notice.



NO.	Description	Part Code		Qty
		GVA48AL-M3NNC7A/I	GVA55AL-M3NNC7A/I	
		Product Code		
1	Right Side Plate Sub-Assy	0130451801	0130451801	1
2	Rear Plate Assy	01304290	01304290	1
3	Right Air Guard	01364507	01364507	1
4	Top Cover Sub-Assy	000051000034	000051000034	1
5	Left Air Guard	01364506	01364506	1
6	Left Side Plate Sub-Assy	0130451901	0130451901	1
7	Evaporator Assy	011001000482	011001000601	1
8	Air Guard Assy	01364509	01364509	1
9	Rear Grill	01474014	01474014	1
10	Chassis	200148000005	200148000005	1
11	Wire Clamp	01384201	01384201	1
12	Fan Motor	1501443307	1501443307	1
13	Water Tray Sub-Assy	12314811	12314811	1
14	Breakwater Sub-Assy	01364154P	01364154P	1
15	Protection Cover	20124062	20124062	1
16	Remote Control Panel Sub-assy	20903400001	20903400001	3
17	Centrifugal Fan	10314401	10314401	1
18	Propeller Housing Sub-assy	12104058	12104058	1
19	Diversioin Circle	10374435	10374435	1
20	Gasket	70414201	70414201	1
21	Electric Box Cover Sub-Assy	01404388	01404388	1
22	Electric Box Assy	100002002913	100002002913	1
23	Main Board	300002000687	300002000687	1
24	Capacitor CBB61S	3301074707	3301074707	1
25	Terminal Board	42010052	42010052	1
26	Motor Cover	22244170	22244170	1
27	SteppingMotor	1521210104	1521210104	1
28	Air Guide Bushing	1054420302	1054420302	6
29	Guide Blade Lever	200235000004	200235000004	1
30	SteppingMotor	15212115	15212115	1
31	Crank 1	10564204	10564204	1
32	Air Louver 1	200007000028	200007000028	1
33	Air Louver 2	200007000029	200007000029	5
34	Crankshaft of Guide Louver	1056420502	1056420502	6
35	Guide Louver	200004000023	200004000023	6
36	Air Outlet Panel Assy	000039000005	000039000005	1
37	Display Sub-Assy	000057000030	000057000030	1
38	Display Board	300001000198	300001000198	1
39	Remote Controller	305001000125	305001000125	1
40	Screw Cover	200005000006	200005000006	2
41	Air Intake Panel Assy	209006000002	209006000002	1
42	Filter (lower)	11124012	11124012	1
43	Filter Sub-assy(Upper)	111001000032	111001000032	1
44	Connecting Cable	4003213471	4003213471	1
45	Connecting Cable	400205399	400205399	1
46	Connecting Cable	4002053910	4002053910	1

Above data is subject to change without notice.

## 10.2 Outdoor Unit

GVA24AL-K3NNC7A/O

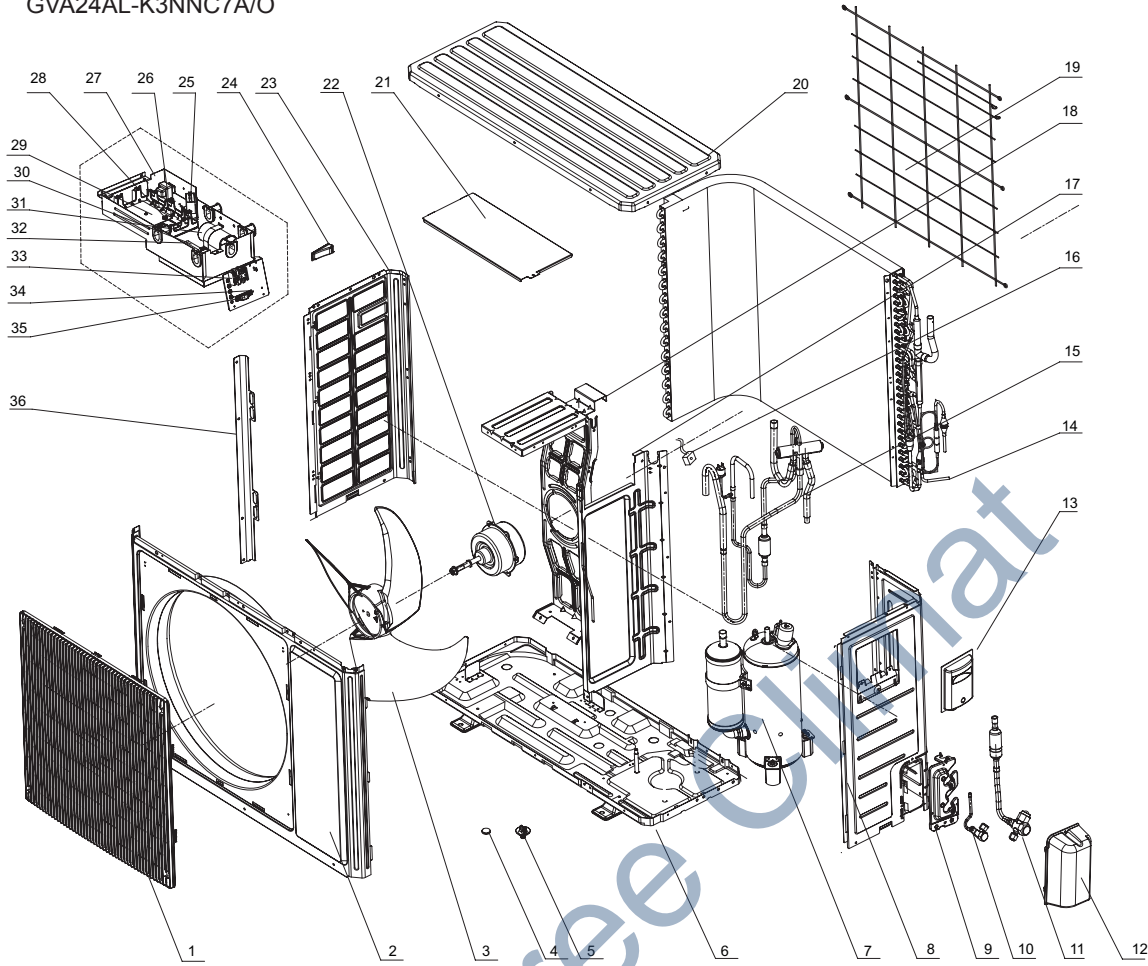

The component picture is only for reference; please refer to the actual product.

NO.	Description	Part Code	Qty
		GVA24AL-K3NNC7A/O	
		Product Code	
		CG156W00200	
1	Front Grill	22415010	1
2	Front Panel	01535013P	1
3	Axial Flow Fan	10335008	2
4	Drainage Joint	06123401	1
5	Drainage hole Cap	06813401	1
6	Chassis Sub-assy	017000000276P	1
7	Compressor and Fittings	009001000217	1
8	Right Side Plate Assy	0130329201	1
9	Valve Support Sub-Assy	01705046P	/
10	Cut off Valve Sub-Assy(1/4)	030057000029	1
11	Cut off Valve Sub-Assy	030057000050	1
12	Valve Cover	22245002	1
13	Handle	26233053	/
14	Condenser Assy	011002000688	1
15	4-Way Valve Assy	030152000406	2
16	Magnet Coil	4300040047	1
17	Clapboard	01245200018	/
18	Motor Support Sub-Assy	01705036	1
19	Rear Grill	01473043	1
20	Coping	012049000007P	1
21	Electric Box Cover	01429400023	1
22	Fan Motor	1501506310	1
23	Left Side Plate	01305093P	1
24	Handle	2623525404	1
25	Capacitor CBB61S	3301074706	1
26	Transformer	43118000004	1
27	Electric Box 1	01429400024	1
28	Jumper	4202300103	/
29	Main Board	300027000489	1
30	AC Contactor	44010245	1
31	Capacitor CBB65	3300008113	1
32	Electric Box Assy	100002003738	1
33	Terminal Board	420001000002	2
34	Insulation Gasket	70410503	1
35	Wire Clamp	71010102	1
36	Supporting Board(Condenser)	01795010	1

Above data is subject to change without notice.



NO.	Description	Part Code		Qty
		GVA48AL-M3NNC7A/O	GVA55AL-M3NNC7A/O	
	Product Code	CG156W00300	CG156W00100	
1	Front Grill	01473001	01473001	2
2	Cabinet	0143543601	0143543601	1
3	Axial Flow Fan	10338731	10338731	2
4	Fan Motor	1501506705	1501506705	2
5	Motor Support Sub-Assy	01705070	01705070	1
6	Condenser Assy	011002000606	011002060087	1
7	Coping	01255013P	01255013P	1
8	Rear Grill	01475006	01475006	1
9	Electric Box Assy	100002002918	100002002917	1
10	AC Contactor	44010226	44010226	1
11	Jumper	4202300118	4202300119	1
12	Terminal Board	42011103	42011103	1
13	Terminal Board	42010328	42010328	1
14	Capacitor CBB61S	3301074705	3301074705	2
15	Phase Reverse Protector	430055000001	430055000001	1
16	Gas-liquid Separator	07220030	07220030	1
17	4-Way Valve Assy	030152000364	030152000393	1
18	Magnet Coil	4300040022	4300040047	1
19	Inhalation Tube Sub-assy	030010000575	030010000614	1
20	Capillary Sub-assy	030006000537	030006000580	1
21	Handle	26235253	26235253	2
22	Rear Side Plate Assy	01305102	01305102	1
23	Valve Support Sub-Assy	0171500101	0171500101	1
24	Compressor and Fittings	009001000239	009001000249	1
25	Compressor Gasket	009012000001	009012000001	4
26	Electrical Heater	7651873203	7651873203	1
27	Clapboard Assy	000075000005	000075000005	1
28	Chassis Sub-assy	01700000156P	01700000156P	1
29	Front Side Plate Sub-Assy	01305034	01305034	1
30	Drainage Joint	06123401	06123401	1
31	Ambient Temperature Sensor	3900020626	3900020626	1
32	Temperature Sensor	3900012137	3900012137	1
33	Temperature Sensor	3900020723	3900012128	1
34	Main Board	300027000481	300027000481	1

Above data is subject to change without notice.

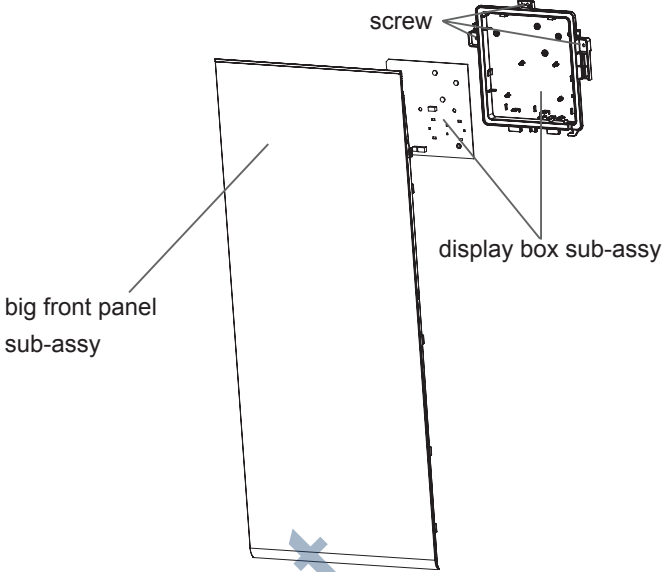
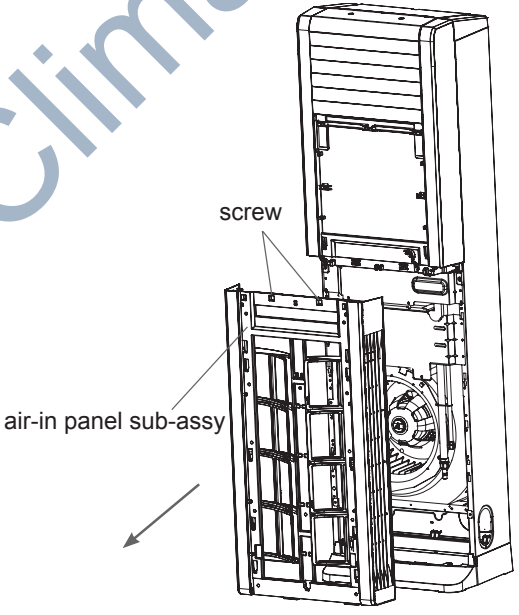
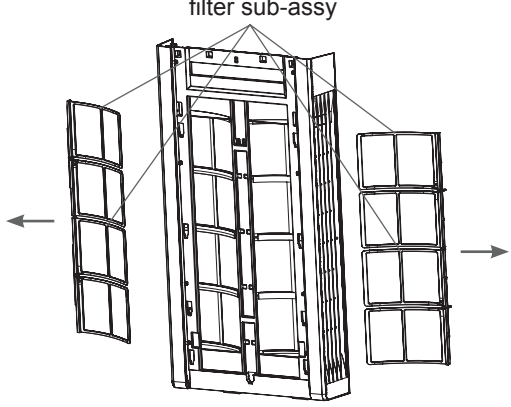

Step	Procedure
<p>3.Remove display box sub-assy</p>	<p>Take out the connection wire of display from the wire groove, remove the fixing screws of display box sub-assy, and then remove the display box sub-assy.</p> 
<p>4. Remove air-in panel sub-assy</p>	<p>Remove two screws on the air-in panel sub-assy. Open the air-in panel along the arrow direction and then remove the air-in panel.</p> 
<p>5.Remove filter sub-assy</p>	<p>Extend your hands into grooves at both sides, pull it outwards and then draw out 4 filters.</p> 

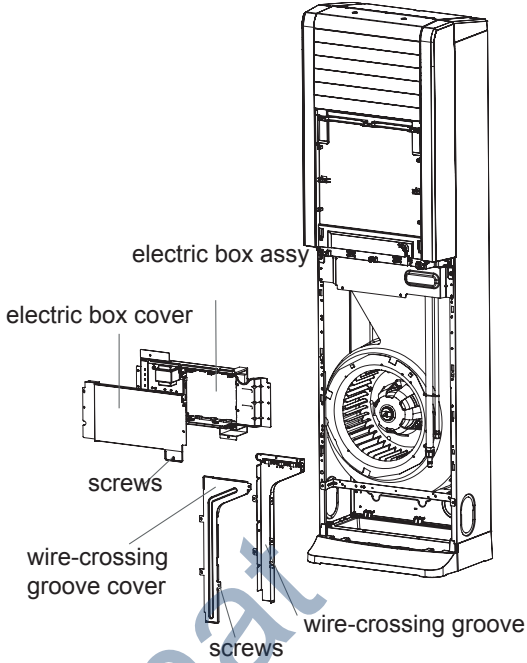
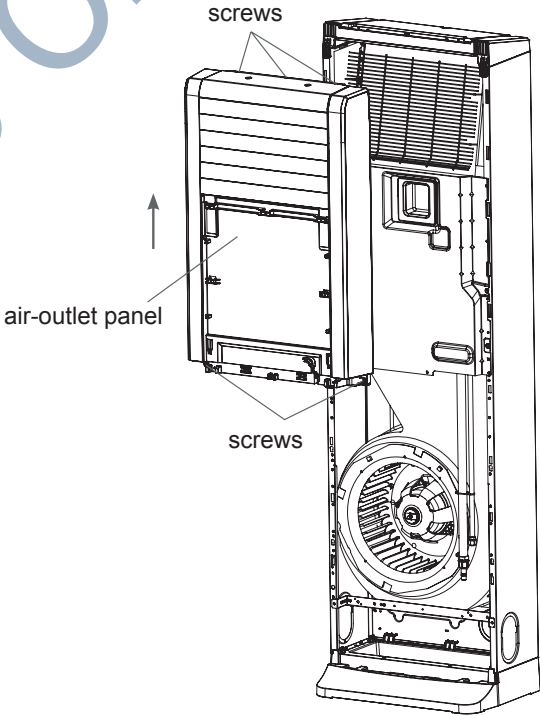
Step	Procedure
<p>6.Remove electric box and wire-passing groove sub-assy</p>	<p>Remove the four screws fixing the electric box cover and then remove the electric box cover; disconnect the wiring terminal of each electronic components and then remove related electronic components according to your requirements;</p> <ol style="list-style-type: none"> <li>1.Remove the two screws fixing the electric box assy and then lift the electric box assy outwards to remove it;</li> <li>2.Remove the four screws fixing the cover of wire-crossing groove and then remove the cover of wire-crossing groove;</li> <li>3.Remove the four screws fixing the wire-crossing groove and then remove the wire-crossing groove sub-assy.</li> </ol> 
<p>7.Remove air-outlet panel</p>	<p>Remove the three screws at the top and two screws at the lower part of air outlet panel and screws in the screw covers at two sides; push the air outlet panel upwards slightly to remove the air outlet panel assy.</p> 

Gree Climat

Step	Procedure	Diagram
<p>8.Remove upper cover, horizontal louver, swing board</p> <p>a Remove 2 screws at the upper part of the upper cover and two screws at the back side of the air-outlet panel.</p> <p>b After removing the air-guiding connecting robe, and then pull the horizontal louver outwards to remove it.</p> <p>c After removing the air swing connection rod, pull the swing board inwards to remove it.</p>		
<p>9.Remove swing motor and air-guide motor</p> <p>a Remove screws used for fixing the air-guide motor and the remove the air-guide motor.</p> <p>b Remove screws used for fixing the motor cover, remove the motor cover and then remove the swing motor.</p>		
<p>10.Remove wind board</p> <p>Remove 11 screws used for fixing the wind board and then remove the wind board.</p>		



Step	Procedure	Diagram
13. Remove evaporator	<p>Remove 4 screws used for fixing the top connection board and lower connection board of evaporator and 2 screws used for fixing the side plate, pull left and right side plates outwards slightly and take out evaporator, baffle board and water tray. After the evaporator is removed, remove left and right wind boards on the evaporator and the baffle board.</p>	
14. Remove propeller housing, centrifugal blade and motor	<p>a Remove 3 screws used for fixing the press plate of propeller housing, and then take out the pressure plate of propeller housing.</p> <p>b Rotate the diversion loop to a certain position in the clockwise direction and then take out the diversion loop,</p> <p>c Remove 9 screws used for fixing the propeller housing and then take out the propeller housing.</p> <p>d Use wrench to remove the nuts used for fixing the centrifugal blade and then pull the centrifugal blade outwards.</p> <p>e Take out the centrifugal blade.</p> <p>f Remove 4 screws fixing the motor and 2 screws fixing the wire-pressing late, and then remove the motor.</p>	

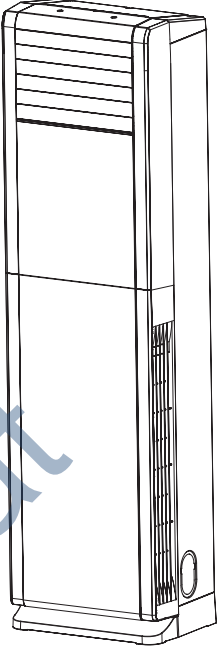
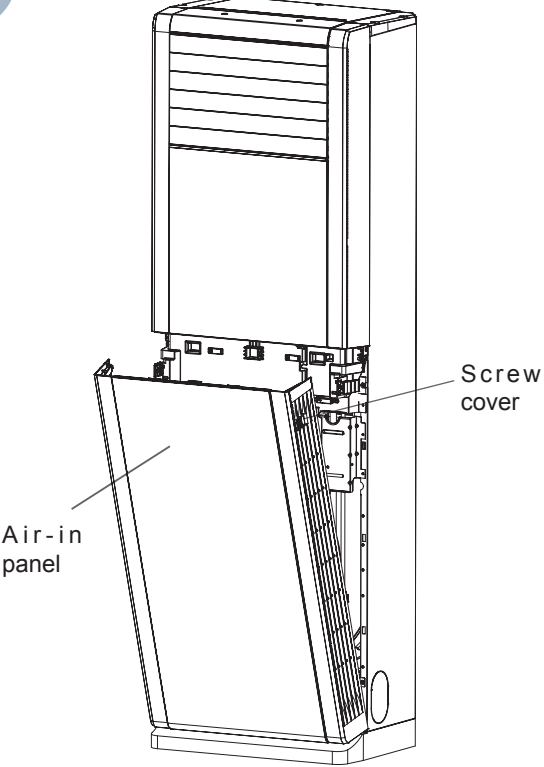

48/55K

Step	Procedure
1. Outside view of indoor unit	
2. Remove air-in panel	<p data-bbox="212 1146 706 1288">Open the screw cover, use screwdriver to remove screws used for fixing the air-in panel at both sides, and then remove the air-in panel.</p> 

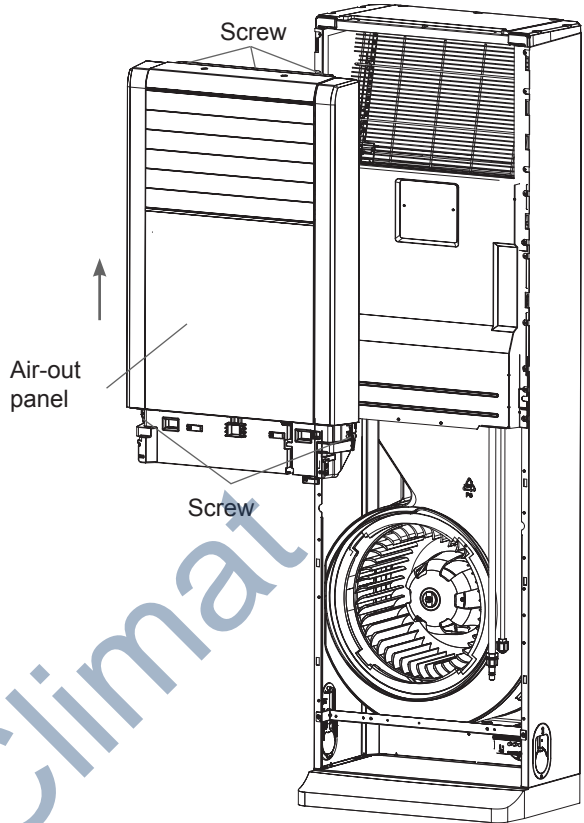
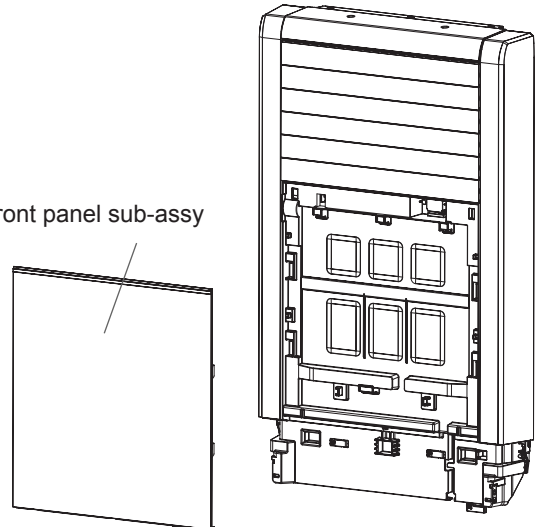

Step	Procedure
<p>5.Remove air-out panel</p>	<p>Remove 3 screws at the top part of the air-out panel, 2 screw at the lower part and screws under the screw cover, push the air-output panel upwards slightly and then remove the air-output panel.</p> 
<p>6.Remove big front panel sub-assy</p>	<p>Remove 2 screws at the lower part, and then pull the big front panel sub-assy downwards slightly to remove it.</p> 

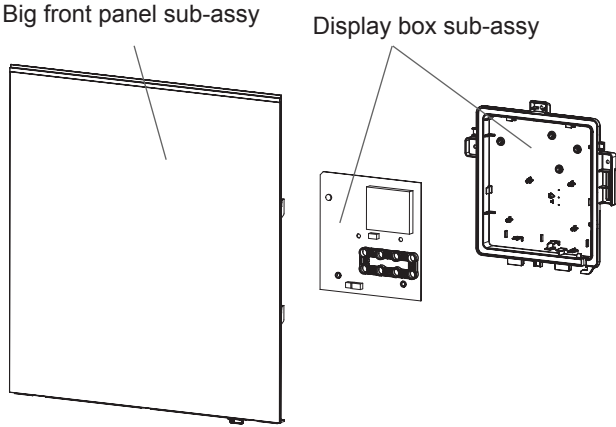
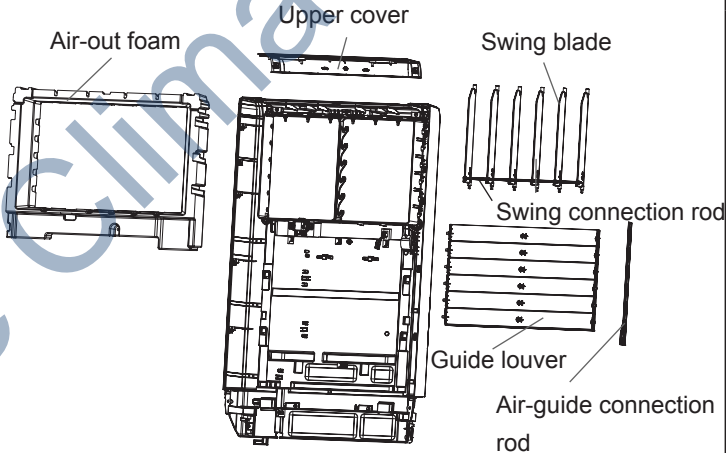
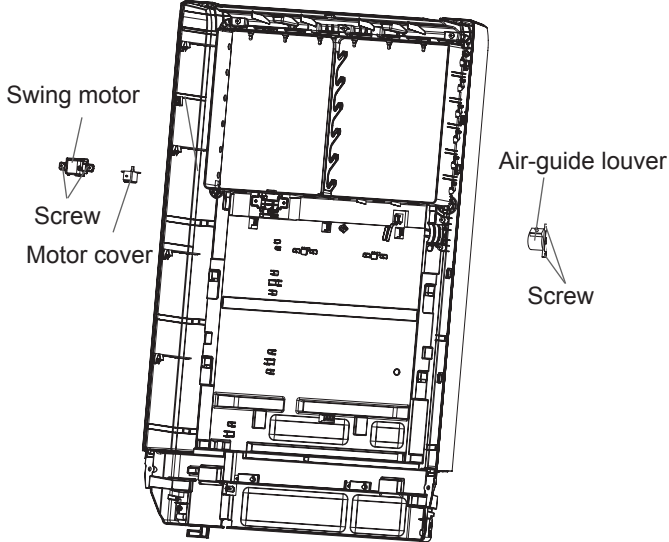
Step	Procedure	Diagram
7.Remove display box	<p>Take out the display connection wire from the wire groove, remove 2 screw at the back of the display cover and then remove the display cover sub-assy.</p>	 <p>Big front panel sub-assy      Display box sub-assy</p>
8.Remove upper cover, air-outlet foam, guide louver, swing blade	<p>a Hold both end of the foam, and then remove the air-outlet foam;</p> <p>b Remove 2 screws at the upper part of the upper cover and 2 screws at the back side, and then the upper cover can be removed.</p> <p>c Remove the air-guide connection rod and then pull the guide louver outwards to remove it.</p> <p>d When the swing connection rod is removed, pull the swing blade outwards to remove it.</p>	 <p>Air-out foam      Upper cover      Swing blade</p> <p>Swing connection rod</p> <p>Guide louver</p> <p>Air-guide connection rod</p>
9.Remove swing motor and air-guide motor	<p>a Remove screws used for fixing the air guide motor, and then the air guide motor can be removed.</p> <p>b Remove screws used for fixing the motor cover, remove the motor cover and then the swing motor can be removed.</p>	 <p>Swing motor</p> <p>Screw</p> <p>Motor cover</p> <p>Air-guide louver</p> <p>Screw</p>

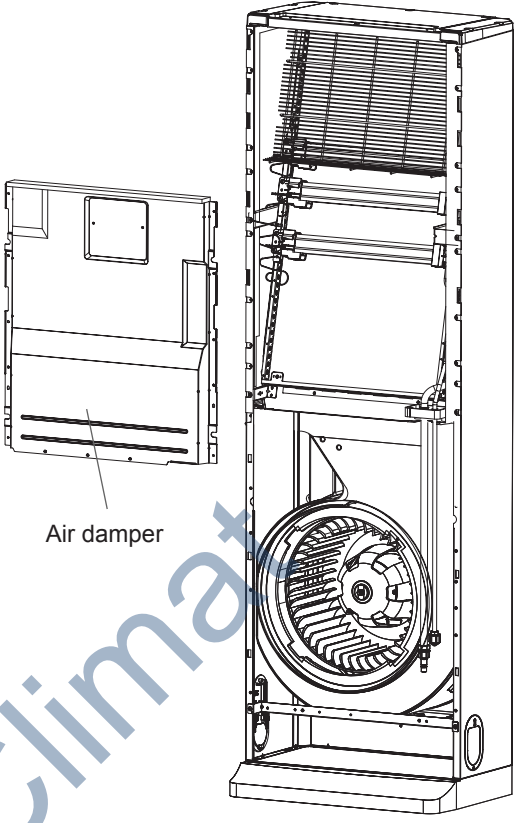
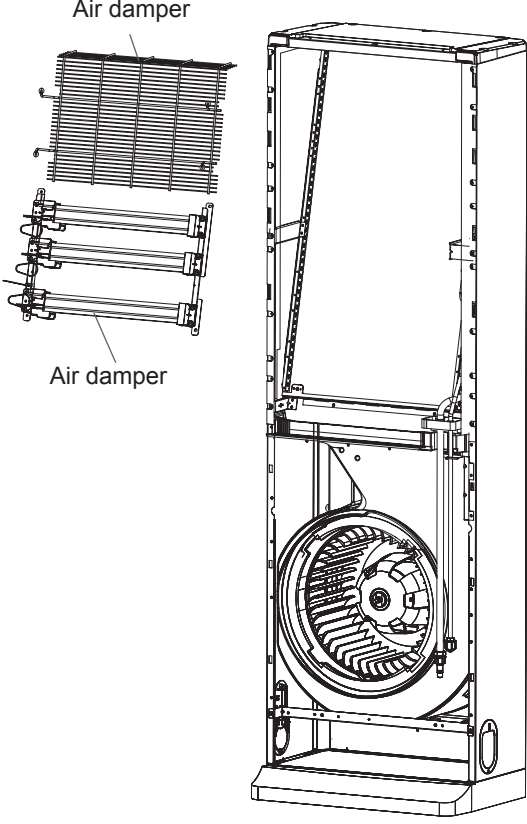
Step	Procedure
<p>10. Remove air damper</p>	<p>Remove 10 screws used for fixing the air damper, and then the air damper can be removed.</p> 
<p>11. Remove electric heating part</p>	<p>Remove 4 screws on the protective grille and then remove the protective grille; Remove 4 screws on the electric heating part and then remove the electric heating part.</p> 



Step	Procedure
<p>14. Remove propeller housing, centrifugal blade and motor</p> <p>a Remove 3 screws used for fixing the press plate of propeller housing and then remove the press plate of propeller housing;</p> <p>b Rotate the guide loop to a certain position along the clockwise direction, and then remove the guide loop;</p> <p>c Remove 9 screws used for fixing the propeller housing, and then remove the propeller housing;</p> <p>d Use wrench to twist off the nuts used for fixing the centrifugal chiller and then pull the centrifugal blade outwards;</p> <p>e Remove the centrifugal blade;</p> <p>f Remove 4 nuts used for fixing the motor and 2 screws used for fixing the wire-pressing plate, and then remove the motor.</p>	
<p>15. Remove chassis</p>	<p>After 9 screws are removed, pull the chassis downwards to remove it.</p>



## 11.2 Removal Procedure of Outdoor Unit

24K



**Warning**

**Be sure to wait for a minimum of 10 minutes after turning off all power supplies before disassembly.**

NOTE: Take heat pump for example.

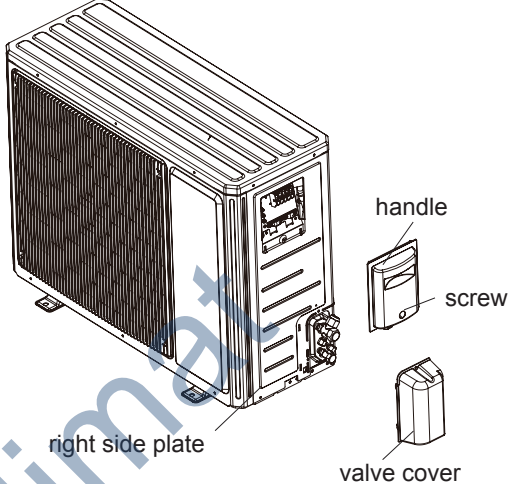
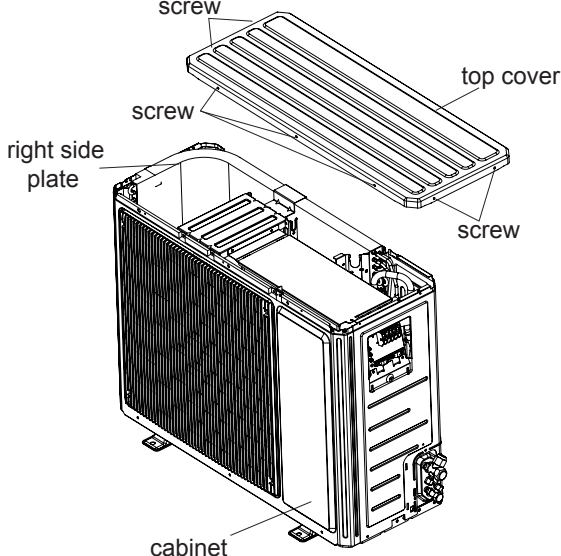
Steps	Procedure
1. Remove big handle, valve cover and top cover	
a	<p>Remove the screw connecting the big handle and right side plate, and then remove the big handle. Remove the screw connecting the valve cover and right side plate, and then remove the valve cover.</p> 
b	<p>Remove the screws connecting the top cover with cabinet, right side plate and left side plate; lift the top cover upwards to remove it.</p> 

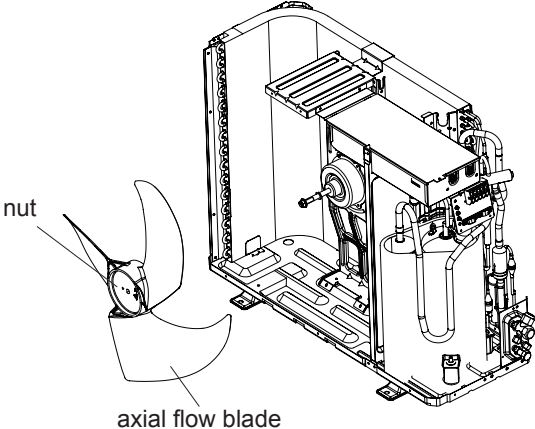
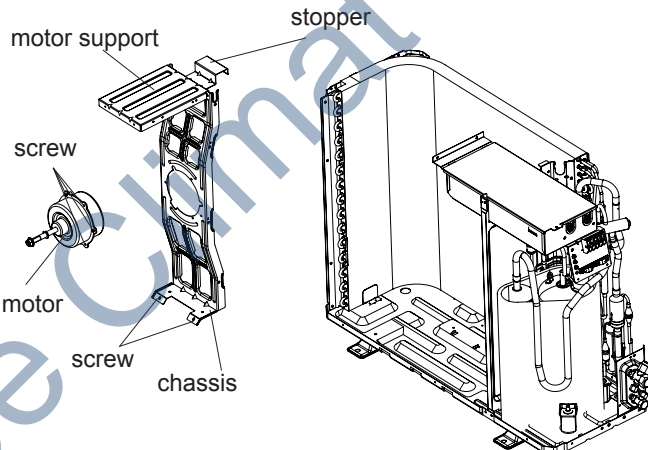
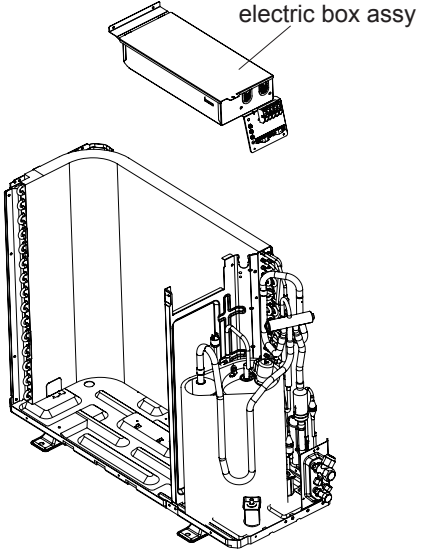

Steps	Procedure
<p>4. Remove axial flow blade</p>	<p>Remove the nut fixing axial flow blade and then remove the blade.</p> 
<p>5. Remove motor support sub-assy and motor</p>	<p>Remove the 2 screws connecting the motor support and chassis, and then loosen the stopper to remove the motor support.</p> <p>Remove the 6 screws fixing the motor and then remove the motor.</p> 
<p>6. Remove electric box assy</p>	<p>Remove the screws fixing electric box assy ; pull out each wiring terminal; lift the electric box assy upwards to remove it.</p> <p>Note: When pulling out the wiring terminal, pay attention to loose the clasp and dont pull it so hard.</p> 

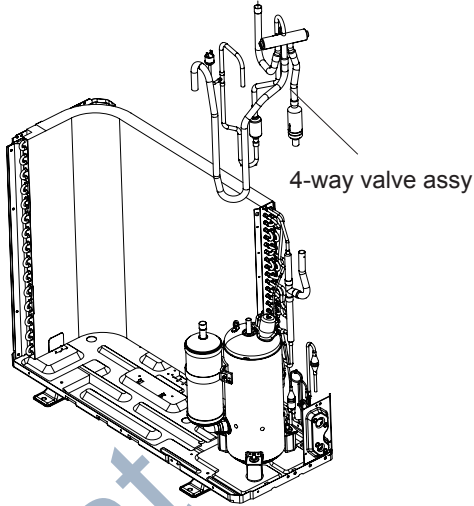
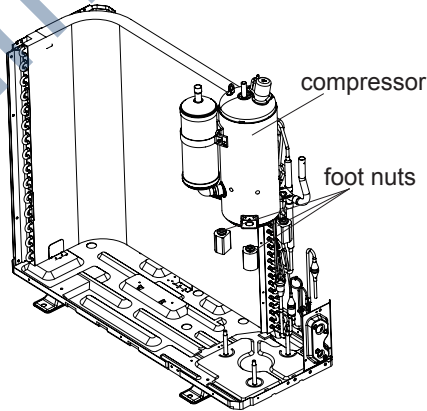

Steps	Procedure
<p>10. Remove 4-way valve assy</p>	<p>Unsolder the welding joints connecting the 4-way valve assy with capillary sub-assy, compressor and condenser; remove the 4-way valve.</p> <p>Note:                      Before unsoldering the welding joint, wrap the 4-way valve with a wet cloth completely to avoid damage to the valve caused by high temperature.</p> 
<p>11. Remove compressor</p>	<p>Remove 3 foot nuts on compressor, and then remove the compressor.</p> <p>Note:                      Protect the ports of discharge pipe and suction pipe to avoid foreign objects to enter it.</p> 

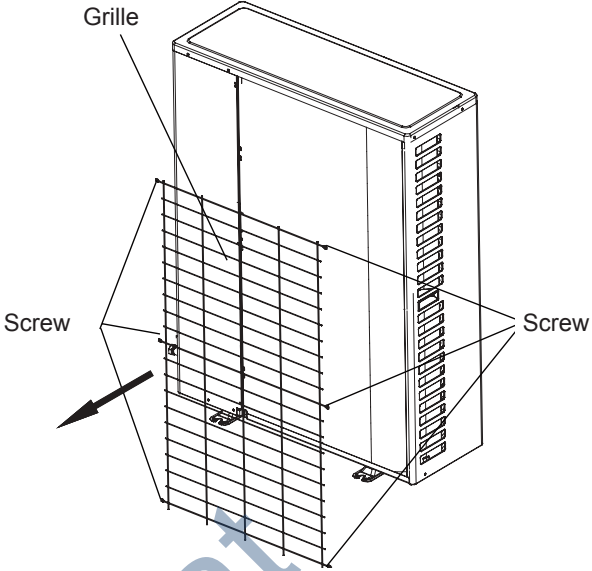
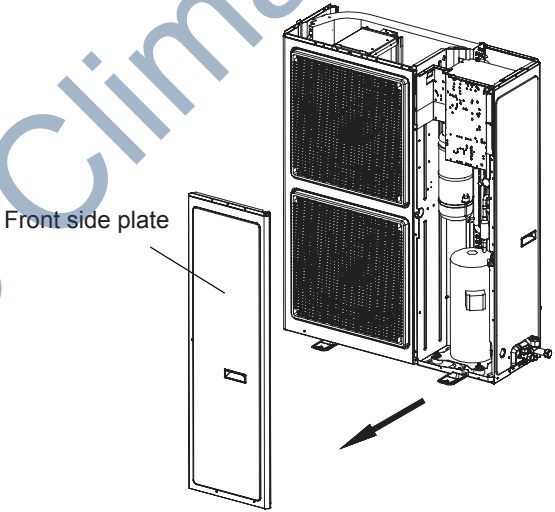
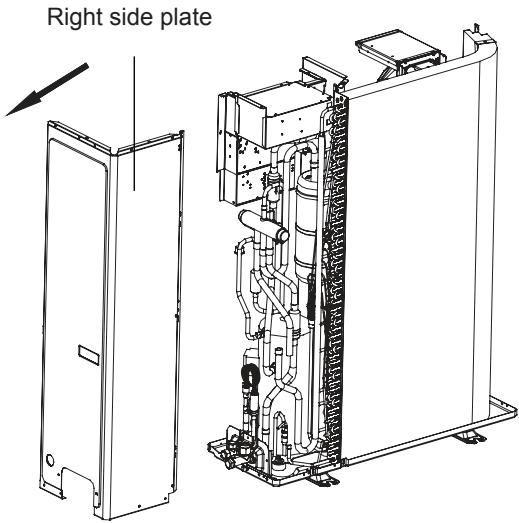

Steps	Procedure
<p>3.Remove grille</p>	<p>Remove screws used for fixing the grille and the rear side plate, the grille and the chassis, and then remove the grille.</p> 
<p>4.Remove front side plate</p>	<p>Remove screws used for fixing the front side plate, lift the front side plate upwards and then remove it.</p> 
<p>5.Remove right side plate</p>	<p>Remove screws used for fixing the right side plate, and then remove the right side plate.</p> 

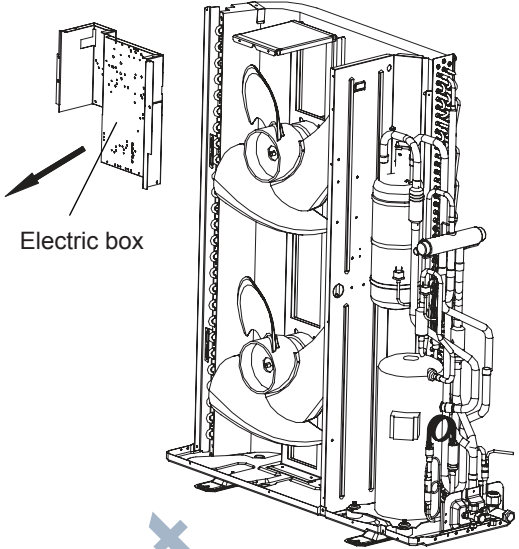
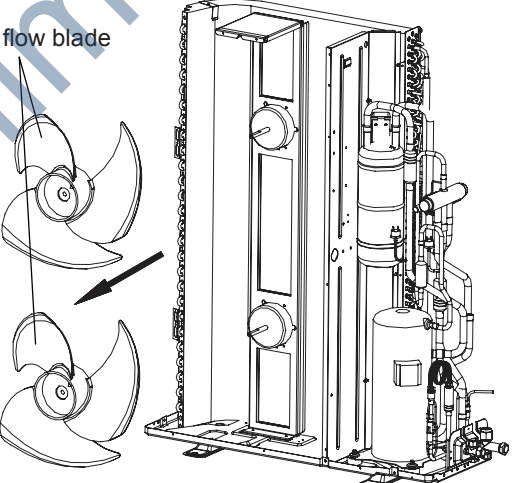
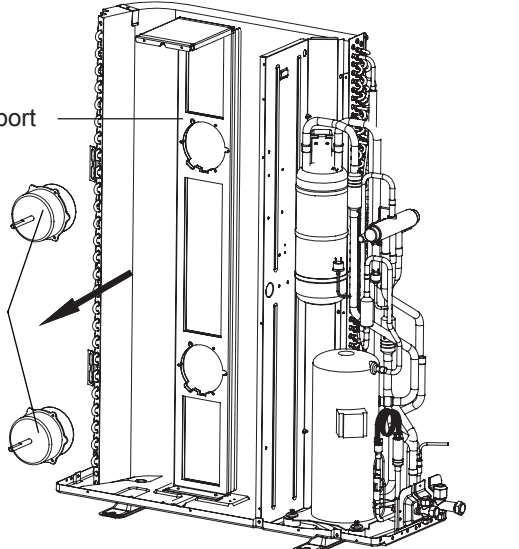
Steps	Procedure
<p>6.Remove electric box</p>	<p>Pull out the connection wires for motor, compressor and temperature sensor, remove screws on the wiring board and screws used for fixing the electric box, and then remove the electric box.</p>  <p>Electric box</p>
<p>7.Remove axial flow blade</p>	<p>Use wrench to loosen the nuts used for fixing the axial flow blade, take out the nut and the washer in turn, and then the axial flow blade can be taken out.</p>  <p>Axial flow blade</p>
<p>8.Remove motor and motor support</p>	<p>Remove screws used for fixing the motor and then remove the motor. Remove the screws used for fixing the motor support, and then lift the motor support to remove it.</p>  <p>Motor support</p> <p>Motor</p>

Gree Climat

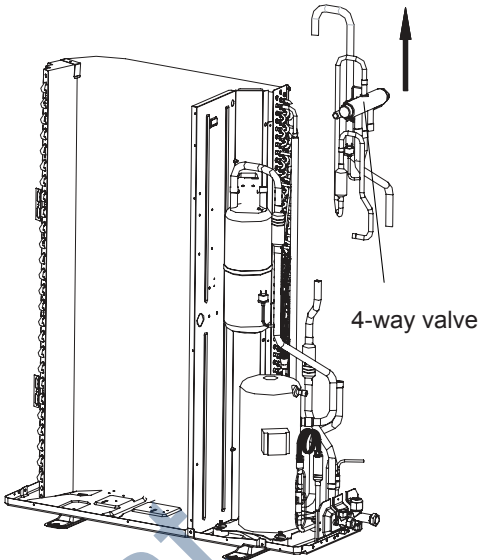
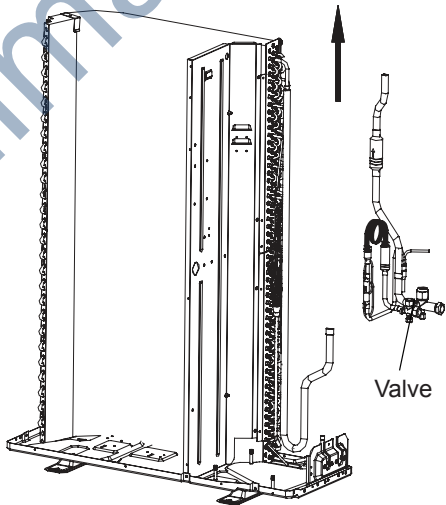
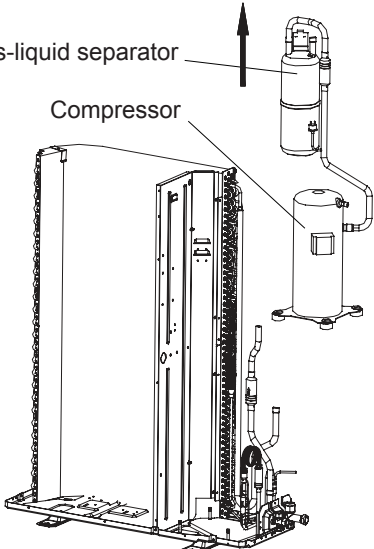
Steps	Procedure
<p>9.Remove 4-way valve</p>	<p>Twist off the nuts used for fixing the 4-way valve wire, and then take out the coil. Use wet gauze to wrap the 4-way valve, unsolder the spot weld connected to the 4-way valve and then remove the 4-way valve. The welding process must be as quick as possible, and then gauze should be kept wet all the time. Please note that don't let the flame burn the leading wired of compressor.</p>  <p>4-way valve</p>
<p>10.Remove valve</p>	<p>Remove screws used for fixing the valve, unsolder the pipeline connected with the valve and then remove the valve.</p>  <p>Valve</p>
<p>11.Remove compressor sub-assy</p>	<p>Unsolder the pipeline connected with the compressor, remove 3 foot nuts on the compressor, and then the compressor and the gas-liquid separator can be removed.</p>  <p>Gas-liquid separator</p> <p>Compressor</p>

## Appendix:

### Appendix 1: Reference Sheet of Celsius and Fahrenheit

Conversion formula for Fahrenheit degree and Celsius degree:  $T_f = T_c \times 1.8 + 32$

#### Set temperature

Fahrenheit display temperature (°F)	Fahrenheit (°F)	Celsius (°C)	Fahrenheit display temperature (°F)	Fahrenheit (°F)	Celsius (°C)	Fahrenheit display temperature (°F)	Fahrenheit (°F)	Celsius (°C)
61	60.8	16	69/70	69.8	21	78/79	78.8	26
62/63	62.6	17	71/72	71.6	22	80/81	80.6	27
64/65	64.4	18	73/74	73.4	23	82/83	82.4	28
66/67	66.2	19	75/76	75.2	24	84/85	84.2	29
68	68	20	77	77	25	86	86	30

#### Ambient temperature

Fahrenheit display temperature (°F)	Fahrenheit (°F)	Celsius (°C)	Fahrenheit display temperature (°F)	Fahrenheit (°F)	Celsius (°C)	Fahrenheit display temperature (°F)	Fahrenheit (°F)	Celsius (°C)
32/33	32	0	55/56	55.4	13	79/80	78.8	26
34/35	33.8	1	57/58	57.2	14	81	80.6	27
36	35.6	2	59/60	59	15	82/83	82.4	28
37/38	37.4	3	61/62	60.8	16	84/85	84.2	29
39/40	39.2	4	63	62.6	17	86/87	86	30
41/42	41	5	64/65	64.4	18	88/89	87.8	31
43/44	42.8	6	66/67	66.2	19	90	89.6	32
45	44.6	7	68/69	68	20	91/92	91.4	33
46/47	46.4	8	70/71	69.8	21	93/94	93.2	34
48/49	48.2	9	72	71.6	22	95/96	95	35
50/51	50	10	73/74	73.4	23	97/98	96.8	36
52/53	51.8	11	75/76	75.2	24	99	98.6	37
54	53.6	12	77/78	77	25			

### Appendix 2: Configuration of Connection Pipe

- Standard length of connection pipe
  - 5m, 7.5m, 8m.
- Min. length of connection pipe is 3m.
- Max. length of connection pipe and max. high difference. (More details please refer to the specifications.)
- The additional refrigerant oil and refrigerant charging required after prolonging connection pipe
  - After the length of connection pipe is prolonged for 10m at the basis of standard length, you should add 5ml of refrigerant oil for each additional 5m of connection pipe.
  - The calculation method of additional refrigerant charging amount (on the basis of liquid pipe):
  - Basing on the length of standard pipe, add refrigerant according to the requirement as shown in the table. The additional refrigerant charging amount per meter is different according to the diameter of liquid pipe. See the following sheet.
  - Additional refrigerant charging amount = prolonged length of liquid pipe X additional refrigerant charging amount per meter

Additional refrigerant charging amount for R22, R407C, R410A and R134a			
Diameter of connection pipe		Outdoor unit throttle	
Liquid pipe(mm)	Gas pipe(mm)	Cooling only(g/m)	Cooling and heating(g/m)
Φ6	Φ9.5 or Φ12	15	20
Φ6 or Φ9.5	Φ16 or Φ19	15	50
Φ12	Φ19 or Φ22.2	30	120
Φ16	Φ25.4 or Φ31.8	60	120
Φ19	/	250	250
Φ22.2	/	350	350

## Appendix 3: Pipe Expanding Method

**⚠ Note:**

**Improper pipe expanding is the main cause of refrigerant leakage. Please expand the pipe according to the following steps:**

**A: Cut the pip**

- Confirm the pipe length according to the distance of indoor unit and outdoor unit.
- Cut the required pipe with pipe cutter.

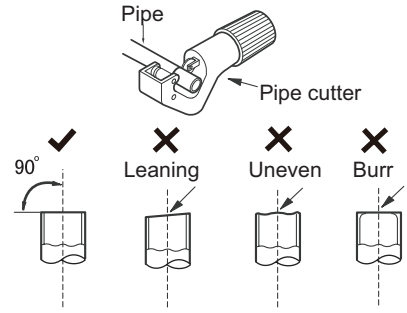

**B: Remove the burrs**

- Remove the burrs with shaper and prevent the burrs from getting into the pipe.

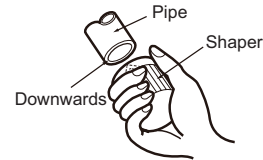

**C: Put on suitable insulating pipe**

**D: Put on the union nut**

- Remove the union nut on the indoor connection pipe and outdoor valve; install the union nut on the pipe.

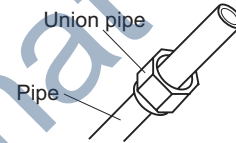

**E: Expand the port**

- Expand the port with expander.

**⚠ Note:**

- "A" is different according to the diameter, please refer to the sheet below:

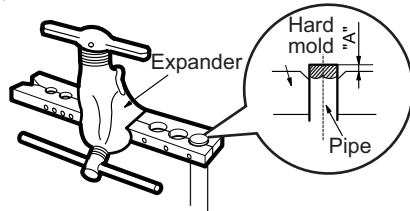

Outer diameter(mm)	A(mm)	
	Max	Min
Φ6 - 6.35 (1/4")	1.3	0.7
Φ9.52 (3/8")	1.6	1.0
Φ12 - 12.70 (1/2")	1.8	1.0
Φ16 - 15.88 (5/8")	2.4	2.2

**F: Inspection**

- Check the quality of expanding port. If there is any blemish, expand the port again according to the steps above.

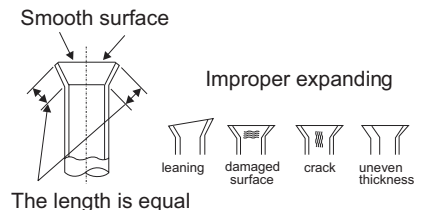

## Appendix 4: List of Resistance for Temperature Sensor

Resistance Table of Ambient Temperature Sensor for Indoor and Outdoor Units(15K)

Temp(°C)	Resistance(kΩ)	Temp(°C)	Resistance(kΩ)	Temp(°C)	Resistance(kΩ)	Temp(°C)	Resistance(kΩ)
-19	138.1	20	18.75	59	3.848	98	1.071
-18	128.6	21	17.93	60	3.711	99	1.039
-17	121.6	22	17.14	61	3.579	100	1.009
-16	115	23	16.39	62	3.454	101	0.98
-15	108.7	24	15.68	63	3.333	102	0.952
-14	102.9	25	15	64	3.217	103	0.925
-13	97.4	26	14.36	65	3.105	104	0.898
-12	92.22	27	13.74	66	2.998	105	0.873
-11	87.35	28	13.16	67	2.896	106	0.848
-10	82.75	29	12.6	68	2.797	107	0.825
-9	78.43	30	12.07	69	2.702	108	0.802
-8	74.35	31	11.57	70	2.611	109	0.779
-7	70.5	32	11.09	71	2.523	110	0.758
-6	66.88	33	10.63	72	2.439	111	0.737
-5	63.46	34	10.2	73	2.358	112	0.717
-4	60.23	35	9.779	74	2.28	113	0.697
-3	57.18	36	9.382	75	2.206	114	0.678
-2	54.31	37	9.003	76	2.133	115	0.66
-1	51.59	38	8.642	77	2.064	116	0.642
0	49.02	39	8.297	78	1.997	117	0.625
1	46.6	40	7.967	79	1.933	118	0.608
2	44.31	41	7.653	80	1.871	119	0.592
3	42.14	42	7.352	81	1.811	120	0.577
4	40.09	43	7.065	82	1.754	121	0.561
5	38.15	44	6.791	83	1.699	122	0.547
6	36.32	45	6.529	84	1.645	123	0.532
7	34.58	46	6.278	85	1.594	124	0.519
8	32.94	47	6.038	86	1.544	125	0.505
9	31.38	48	5.809	87	1.497	126	0.492
10	29.9	49	5.589	88	1.451	127	0.48
11	28.51	50	5.379	89	1.408	128	0.467
12	27.18	51	5.197	90	1.363	129	0.456
13	25.92	52	4.986	91	1.322	130	0.444
14	24.73	53	4.802	92	1.282	131	0.433
15	23.6	54	4.625	93	1.244	132	0.422
16	22.53	55	4.456	94	1.207	133	0.412
17	21.51	56	4.294	95	1.171	134	0.401
18	20.54	57	4.139	96	1.136	135	0.391
19	19.63	58	3.99	97	1.103	136	0.382

**Resistance Table of Tube Temperature Sensors for Outdoor and Indoor(20K)**

Temp(°C)	Resistance(kΩ)	Temp(°C)	Resistance(kΩ)	Temp(°C)	Resistance(kΩ)	Temp(°C)	Resistance(kΩ)
-19	181.4	20	25.01	59	5.13	98	1.427
-18	171.4	21	23.9	60	4.948	99	1.386
-17	162.1	22	22.85	61	4.773	100	1.346
-16	153.3	23	21.85	62	4.605	101	1.307
-15	145	24	20.9	63	4.443	102	1.269
-14	137.2	25	20	64	4.289	103	1.233
-13	129.9	26	19.14	65	4.14	104	1.198
-12	123	27	18.13	66	3.998	105	1.164
-11	116.5	28	17.55	67	3.861	106	1.131
-10	110.3	29	16.8	68	3.729	107	1.099
-9	104.6	30	16.1	69	3.603	108	1.069
-8	99.13	31	15.43	70	3.481	109	1.039
-7	94	32	14.79	71	3.364	110	1.01
-6	89.17	33	14.18	72	3.252	111	0.983
-5	84.61	34	13.59	73	3.144	112	0.956
-4	80.31	35	13.04	74	3.04	113	0.93
-3	76.24	36	12.51	75	2.94	114	0.904
-2	72.41	37	12	76	2.844	115	0.88
-1	68.79	38	11.52	77	2.752	116	0.856
0	65.37	39	11.06	78	2.663	117	0.833
1	62.13	40	10.62	79	2.577	118	0.811
2	59.08	41	10.2	80	2.495	119	0.77
3	56.19	42	9.803	81	2.415	120	0.769
4	53.46	43	9.42	82	2.339	121	0.746
5	50.87	44	9.054	83	2.265	122	0.729
6	48.42	45	8.705	84	2.194	123	0.71
7	46.11	46	8.37	85	2.125	124	0.692
8	43.92	47	8.051	86	2.059	125	0.674
9	41.84	48	7.745	87	1.996	126	0.658
10	39.87	49	7.453	88	1.934	127	0.64
11	38.01	50	7.173	89	1.875	128	0.623
12	36.24	51	6.905	90	1.818	129	0.607
13	34.57	52	6.648	91	1.736	130	0.592
14	32.98	53	6.403	92	1.71	131	0.577
15	31.47	54	6.167	93	1.658	132	0.563
16	30.04	55	5.942	94	1.609	133	0.549
17	28.68	56	5.726	95	1.561	134	0.535
18	27.39	57	5.519	96	1.515	135	0.521
19	26.17	58	5.32	97	1.47	136	0.509

## Resistance Table of Discharge Temperature Sensor for Outdoor(50K)

Temp(°C)	Resistance(kΩ)	Temp(°C)	Resistance(kΩ)	Temp(°C)	Resistance(kΩ)	Temp(°C)	Resistance(kΩ)
-29	853.5	10	98	49	18.34	88	4.75
-28	799.8	11	93.42	50	17.65	89	4.61
-27	750	12	89.07	51	16.99	90	4.47
-26	703.8	13	84.95	52	16.36	91	4.33
-25	660.8	14	81.05	53	15.75	92	4.20
-24	620.8	15	77.35	54	15.17	93	4.08
-23	580.6	16	73.83	55	14.62	94	3.96
-22	548.9	17	70.5	56	14.09	95	3.84
-21	516.6	18	67.34	57	13.58	96	3.73
-20	486.5	19	64.33	58	13.09	97	3.62
-19	458.3	20	61.48	59	12.62	98	3.51
-18	432	21	58.77	60	12.17	99	3.41
-17	407.4	22	56.19	61	11.74	100	3.32
-16	384.5	23	53.74	62	11.32	101	3.22
-15	362.9	24	51.41	63	10.93	102	3.13
-14	342.8	25	49.19	64	10.54	103	3.04
-13	323.9	26	47.08	65	10.18	104	2.96
-12	306.2	27	45.07	66	9.83	105	2.87
-11	289.6	28	43.16	67	9.49	106	2.79
-10	274	29	41.34	68	9.17	107	2.72
-9	259.3	30	39.61	69	8.85	108	2.64
-8	245.6	31	37.96	70	8.56	109	2.57
-7	232.6	32	36.38	71	8.27	110	2.50
-6	220.5	33	34.88	72	7.99	111	2.43
-5	209	34	33.45	73	7.73	112	2.37
-4	198.3	35	32.09	74	7.47	113	2.30
-3	199.1	36	30.79	75	7.22	114	2.24
-2	178.5	37	29.54	76	7.00	115	2.18
-1	169.5	38	28.36	77	6.76	116	2.12
0	161	39	27.23	78	6.54	117	2.07
1	153	40	26.15	79	6.33	118	2.02
2	145.4	41	25.11	80	6.13	119	1.96
3	138.3	42	24.13	81	5.93	120	1.91
4	131.5	43	23.19	82	5.75	121	1.86
5	125.1	44	22.29	83	5.57	122	1.82
6	119.1	45	21.43	84	5.39	123	1.77
7	113.4	46	20.6	85	5.22	124	1.73
8	108	47	19.81	86	5.06	125	1.68
9	102.8	48	19.06	87	4.90	126	1.64



JF00303472

Gree Climat



GREE ELECTRIC APPLIANCES, INC. OF ZHUHAI

Add: West Jinji Rd, Qianshan, Zhuhai,Guangdong, China, 519070  
Tel: (+86-756) 8522218  
Fax: (+86-756) 8669426  
E-mail: [gree@gree.com.cn](mailto:gree@gree.com.cn) [www.gree.com](http://www.gree.com)

HONG KONG GREE ELECTRIC APPLIANCES SALES LIMITED

Add: Unit 2612,26/F.,Miramar Tower 132 Nathan Road,TST,Kowloon,HK  
Tel: (852) 31658898 Fax: (852) 31651029

**For product improvement, specifications and appearance in this manual are subject to change without prior notice.**