

Operation and Maintenance Documentation GUARD PRO EC

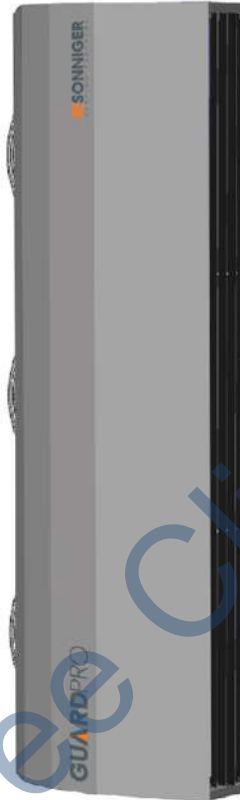

1. PURPOSE OF THE DEVICE

The industrial air curtain is intended to be used in regions with a moderate and cold climate, in spaces where the temperature ranges from -15 to +40°C and with relative humidity up to 80% (at the temperature of +25°C), in conditions free from external factors such as pollens, hydrometeor (horizontal precipitation) and chemical vapors.

In winter, air curtains protect against heat losses in rooms which is possible due to the airstream suitably directed that protects the entrance of cold air into a heated space. In summer, the curtains may be used as cooling devices preventing the entry of hot air from outside as well as air pollutants.

The GUARD PRO industrial air curtains are designed to protect against heat losses in the gateways of buildings of medium and high capacity especially as the followings

- ▨ warehouse and production halls,
- ▨ Loading/unloading sections in supermarkets and large commercial premises,
- ▨ Car showrooms and service stations,
- ▨ exhibition surfaces

2. BASIC TECHNICAL PARAMETERS GUARD PRO EC

| PARAMETERS | GUARD PRO | | | | | | | | | | | | | |
|---|---------------------------|--|-------------------|--|------------------------------|--|-------------------|--|------------------------|--|-------------------|--|-------------------|--|
| | Curtain with water heater | | | | Curtain with electric heater | | | | Curtain without heater | | | | | |
| | GUARDPRO 150W | | GUARDPRO 200W | | GUARDPRO 150E | | GUARDPRO 200E | | GUARDPRO 150C | | GUARDPRO 200C | | | |
| Length of unit | m | | 1.5 | | 2 | | 1.5 | | 2 | | 1.5 | | 2 | |
| Max airflow range | m | | 8 | | 8 | | 8 | | 9 | | 9 | | 9 | |
| Heat output * | kW | | 32 | | 46 | | 14 | | 17,5 | | - | | - | |
| Max air output | m ³ /h | | 6 500/4 100/2 750 | | 9 100/5 150/3 400 | | 6 550/4 100/2 700 | | 9 450/5 650/3 750 | | 6 700/4 250/2 750 | | 9 600/5 700/3 800 | |
| Max working pressure | MPa | | 1,6 | | - | | - | | - | | - | | - | |
| Diameter of connection nozzles | inch | | 3/4" | | - | | - | | - | | - | | - | |
| EC Motor power supply, consumption | V/Hz/A | | 230/50 2,18A | | 230/50 3,27A | | 230/50 2,18 A | | 230/50 3,27A | | 230/50 2,18 A | | 230/50 3,27A | |
| EC Motor power | kW | | 0,5 | | 0,75 | | 0,5 | | 0,75 | | 0,5 | | 0,75 | |
| Electric heater power supply, consumption | V/Hz A | | - | | - | | 400 50/60 21,3A | | 400 50/60 26,6A | | - | | - | |
| Weight filled with water / without water | kg | | 53/54 | | 72/74 | | 52 | | 68 | | 44 | | 58 | |
| Noise level*** | dB (A) | | 60 | | 64 | | 59 | | 61 | | 59 | | 61 | |
| Protection class IP | | | IP 54 | | IP 54 | | IP 20 | | IP 20 | | IP 54 | | IP 54 | |

* heat output for water agent 90/70 and inlet air temperature 0°C

** power consumption for ambient air temperature 16°C and cable length 10m. Energy consumption [A] increases when the air inlet temperature decreases or when the length of the supply cables is longer

***measured in distance of 5m

max temperature of heating agent 110°C

DIMENSIONS GUARD PRO EC 150W, GUARD PRO EC 150C, GUARD PRO EC 150E

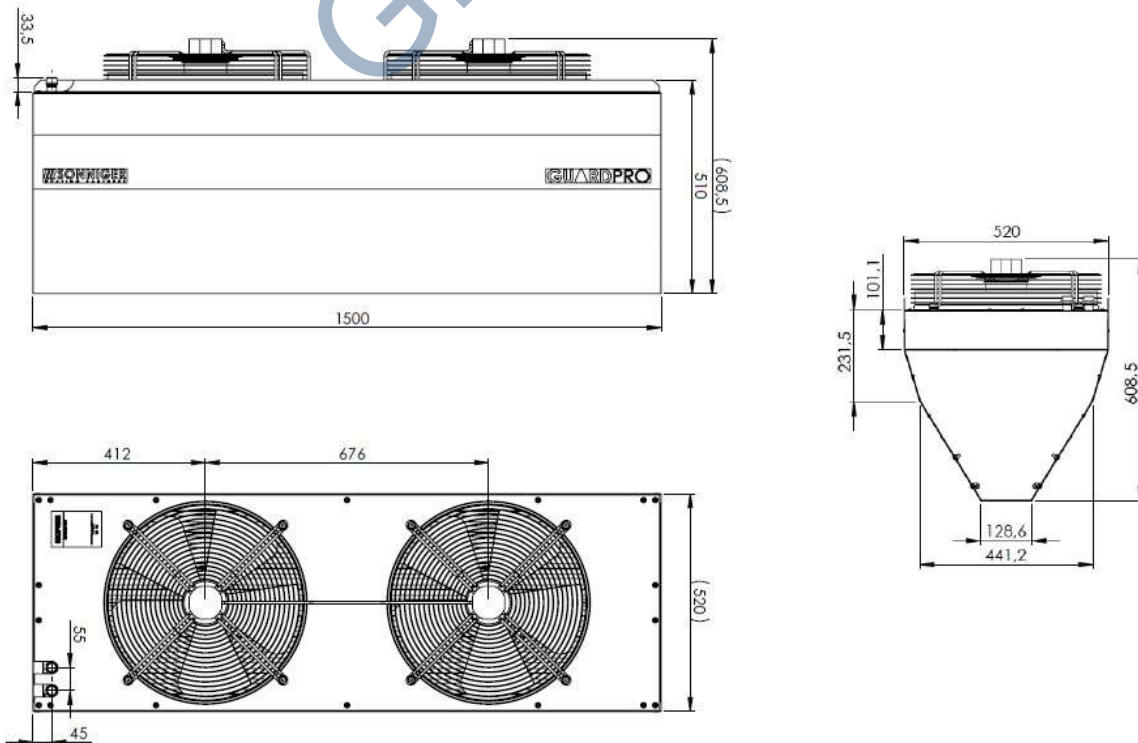

DIMENSIONS GUARD PRO EC 200W, 200E 200C

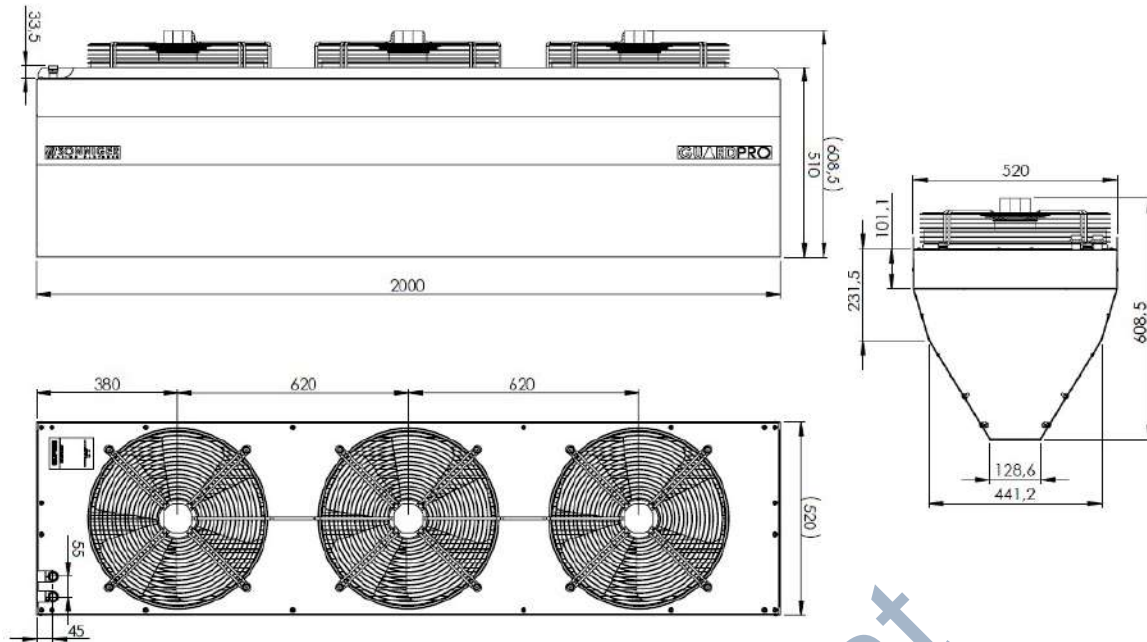

PTC HEATERS

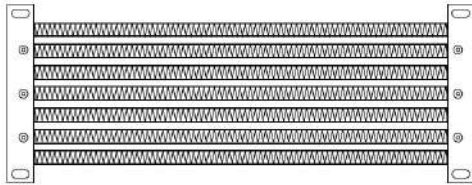

GUARD PRO type E air curtain is equipped with modern PTC electric heaters.

PTC are thermistors which means that along with the temperature increase the resistance of the heating element increases as well. Thanks to that feature there is no risk of overheating which lead to safer devices with more efficient performances. An additional benefit is a lack of current on the surface of the heater as well as a larger energy exchange surface.

3. GENERAL AND SAFETY PRINCIPLES

The GUARD PRO air curtains are manufactured in compliance with the rules and standards concerning quality, ecology, utility, and work comfort. Before starting the device be sure to read the Manual carefully.

The GUARD PRO air curtains are delivered ready-to-use in a cardboard package that protects them from any mechanical damage. The package consists of the device, the Manual (Operation and Maintenance Documentation), and the Guarantee. If the optional automatic control is ordered, it shall be delivered in a separate package. Make sure all the aforementioned elements are in the package immediately after delivery. In the absence of any element, please fill in the suitable carrier document

NOTICE!

- Do not use the curtain in rooms containing any flammable and/or combustible substances, biological substances, or in environments with corrosive air components.
- Do not use the curtain in rooms with relative humidity above 80%
- Do not leave the curtain ON unattended for longer periods
- Do not use the curtain without proper grounding
- Do not turn on the curtain with the protective cover on
- Before conducting any maintenance or cleaning work or during the break-in operation for an extended period, make sure you unplug the power cable
- To connect the air curtain, use a supply cable with a fork that protects against unintended disconnecting from the power
- When the air curtain is connected directly to the cable, please make sure there is a splitter protecting against any undesired disconnecting
- Pay special attention while transporting the device not to damage the casing
- When the device is being operated, ensure the safety rules following the labor standards relating to the operation of any electrical devices
- Do not place any objects on the curtain or reduce the airflow to ensure fire safety and if sparks or a damaged supply cable are noticed, discontinue the operation immediately
- The electricity network, to which the curtain is connected, should be protected against overloading and short circuit

CAUTION!

- ⚠ For reasons of danger to electric shock any exchanges of supply cable must be performed by a qualified specialist
- ⚠ For reasons of danger to electric shock disconnect the power supply before conducting any repair or maintenance work
- ⚠ Any leakage repairs of the heating medium in the device, of which pipes are under pressure, are strictly prohibited
- ⚠ A cut-off/stop valve must be used to supply a heating medium
- ⚠ It is prohibited to connect the grounding-type plug to water pipes, gas tubes, lightning conductors, telephone or antenna network
- ⚠ Wait for at least 3 hours before connecting the device to the supply power if the temperature while transporting is below zero

NOTICE !

- ❶ Before mounting the device, read the manual carefully and adhere to the rules concerning the mounting procedures. Not applying to the rules may result in the inappropriate functioning of the device and the loss of the guarantee rights.
- ❶ Pay special attention when working with electrical elements of the device.

4. ASSEMBLY

Before mounting the unit, take into consideration the followings:

- ⚠ accessibility/easy access for any servicing and maintenance works
- ⚠ access to water and electrical installation
- ⚠ possibility to mount the curtain directly at the gate entrance

It is advisable to mount the device to the wall or the ceiling above the doorway on supporting mount pins or supporting constructions (shapes and dimensions of the supporting construction may be individually designed in compliance with durability and strength requirements).

Pay special attention to the proper leveling of the device. If the device is not placed in a horizontal or vertical position, it may result in damage to the fan and consequently malfunction of the device. The air inlet and outlet must not be blocked by any objects. While installing the unit, remember to provide easy access to the control panel. A few curtains of the same type may be installed in case of a bigger doorway. They must be assembled side-by-side to make an uninterrupted stream of air. The curtain is mounted horizontally or vertically for permanent (on the left/right side of the doorway). The GUARD PRO air curtain is advised to be wider (in case of horizontal mounting) or higher (in case of vertical mounting) than the gateway.

If you decide on an **ACTIVE PROTECTION** system, which is the assembly of curtains with a water exchanger and without one, you have to mount air curtains with water exchangers on the bottom.

When connecting the curtain, make sure that maintenance work is possible to be conducted. On both connection nozzles, manual shut-off valves should be installed in case of the necessity of disconnecting the unit. The hot water medium supply must be connected following the marking on the casing (inlet/outlet).

When pipes are being screwed to the heat exchanger make sure you secure the inlet connection of the heater to protect it against the torque (that may cause leakage in the heat exchanger).

The connections of the heating medium with the threaded nozzles DIN 3/4" should be based on the project carried out by an authorized designer. In case of connecting the curtain to the heating network with no mixing module, a water filter must be installed.

NOTICE !

- ❶ Pay special attention to proper leveling of the device. If the device is not placed horizontally or vertically, it may result in damaging the fan and consequently the malfunction of the device.
- ❶ To sustain proper functioning of the device, keep safe distances as given in Figure below.

4.1. CONNECTING GUARD PRO EC CURTAINS

The GUARDPRO multi-purpose connector is designed to connect curtains and to mount curtains to the ceiling (in case of horizontal mounting) or to the wall (in case of vertical mounting). The GUARDPRO multi-purpose connector is not included in the content of the delivery and is available optionally. The connector should be installed in accordance with the figures below. The required number of the GUARDPRO multi-purpose connectors

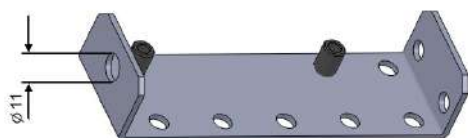

Horizontal assembly (N – number of curtains)

$N \times 4 =$ number of GUARDPRO multi-purpose connectors

Vertical assembly (N - number of curtains)

$(N \times 4) - 2 =$ number of GUARDPRO multi-purpose connectors

may be calculated from the formula below.

Installation of connector inside the curtain



Installation of connector at the back of the curtains

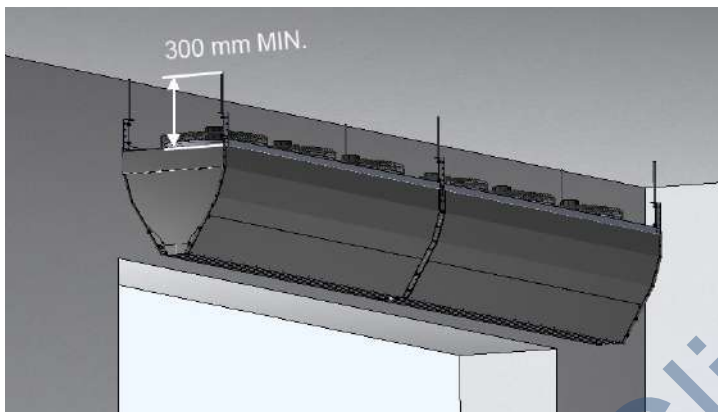
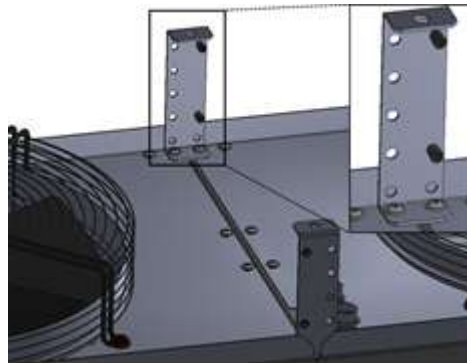

Horizontal assembly

To mount the curtain horizontally in a proper way, keep the distance of min 300mm from the rear side of the device.

To mount the GUARDPRO curtain to the ceiling, use the GUARDPRO multi-purpose connector. Mounting pins of diameter 11 may be attached to the connector (not included in the delivery).

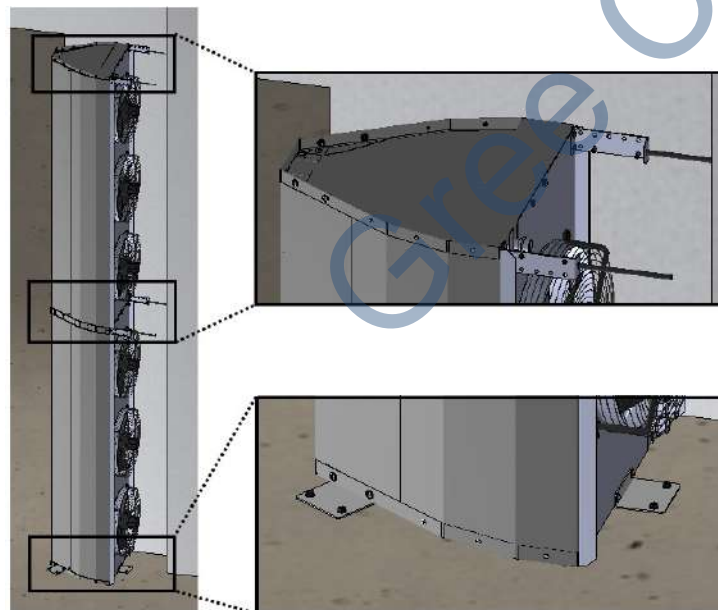

Vertical assembly

To mount the curtain vertically make sure the air outlet of the curtain is as close as possible to the doorway and air gap is at the height of the upper edge of the entry. Please, make sure to keep the distance of about 300 mm between the outlet casing and the wall.

To mount two GUARDPRO curtains one above the other, it is necessary to use the GUARDPRO multi-purpose connector to install the curtain to the wall.

To mount GUARDPRO curtain to the floor, use vertical holder/support, which is used to attach the curtain to the EURO pallet (for the period of transport). The support is included in the delivery. The curtain must be attached to the floor from each side and its rear side as shown in Figure.

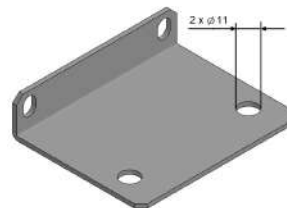

5. HEAT OUTPUT RANGES

| GUARD PRO 150W | | | | | | | | | | | | | | | | | | | | | | | | | | |
|--|-------------------|-------|------|------|------|------|-------|------|------|------|------|-------|------|------|------|------|-------|------|------|------|------|-------|------|------|------|------|
| inlet/outlet water temperature | | 50/30 | | | | | 60/40 | | | | | 70/50 | | | | | 80/60 | | | | | 90/70 | | | | |
| inlet air temperature | | 0 | 5 | 10 | 15 | 20 | 0 | 5 | 10 | 15 | 20 | 0 | 5 | 10 | 15 | 20 | 0 | 5 | 10 | 15 | 20 | 0 | 5 | 10 | 15 | 20 |
| air flow 6500 m³/h (speed 3) | | | | | | | | | | | | | | | | | | | | | | | | | | |
| heat output | kW | 13,5 | 10,9 | 7,7 | 4,6 | 3,4 | 18,3 | 16,1 | 13,7 | 11,3 | 8,5 | 23,4 | 21,3 | 19,1 | 16,9 | 14,8 | 28,0 | 25,8 | 23,6 | 21,5 | 19,3 | 32,5 | 30,3 | 28,2 | 26,0 | 23,8 |
| outlet air temperature | °C | 6,1 | 9,9 | 13,5 | 17,1 | 21,5 | 8,2 | 12,3 | 16,2 | 20,1 | 23,8 | 10,6 | 14,6 | 18,6 | 22,6 | 26,6 | 12,6 | 16,6 | 20,7 | 24,7 | 28,7 | 14,6 | 18,7 | 22,7 | 26,7 | 30,7 |
| water flow | m ³ /h | 0,6 | 0,5 | 0,3 | 0,2 | 0,1 | 0,8 | 0,7 | 0,6 | 0,5 | 0,4 | 1,0 | 0,9 | 0,8 | 0,8 | 0,6 | 1,2 | 1,1 | 1,0 | 0,9 | 0,9 | 1,4 | 1,3 | 1,3 | 1,2 | 1,0 |
| pressure drop | kPa | 1,3 | 0,9 | 0,5 | 0,2 | 0,1 | 2,3 | 1,8 | 1,3 | 0,9 | 0,6 | 3,6 | 3,0 | 2,4 | 1,9 | 1,5 | 4,9 | 4,2 | 3,6 | 3,0 | 2,5 | 6,4 | 5,7 | 4,9 | 4,2 | 3,6 |
| air flow 4100 m³/h (speed 2) | | | | | | | | | | | | | | | | | | | | | | | | | | |
| heat output | kW | 9,7 | 7,4 | 5,0 | 3,9 | 2,9 | 13,6 | 11,9 | 10,0 | 8,0 | 4,9 | 17,7 | 16,1 | 14,4 | 12,7 | 11,0 | 21,1 | 19,5 | 17,8 | 16,2 | 14,6 | 24,5 | 22,8 | 21,2 | 19,6 | 18,0 |
| outlet air temperature | °C | 6,9 | 10,2 | 13,5 | 17,8 | 22 | 9,7 | 13,4 | 17,1 | 20,7 | 23,5 | 12,5 | 16,4 | 20,2 | 24 | 27,8 | 14,9 | 18,8 | 22,6 | 26,5 | 30,3 | 17,3 | 21,2 | 25 | 28,9 | 32,7 |
| water flow | m ³ /h | 0,4 | 0,3 | 0,2 | 0,2 | 0,1 | 0,6 | 0,5 | 0,4 | 0,4 | 0,2 | 0,8 | 0,7 | 0,6 | 0,5 | 0,5 | 0,9 | 0,9 | 0,8 | 0,7 | 0,6 | 1,1 | 1,0 | 0,9 | 0,9 | 0,8 |
| pressure drop | kPa | 0,7 | 0,4 | 0,2 | 0,1 | 0,1 | 1,3 | 1,0 | 0,8 | 0,5 | 0,2 | 2,1 | 1,8 | 1,4 | 1,1 | 0,9 | 2,9 | 2,5 | 2,1 | 1,8 | 1,5 | 3,8 | 3,3 | 2,9 | 2,5 | 2,1 |
| air flow 2750 m³/h (speed 1) | | | | | | | | | | | | | | | | | | | | | | | | | | |
| heat output | kW | 6,9 | 5,2 | 4,3 | 3,4 | 2,5 | 10,4 | 9,0 | 7,4 | 5,5 | 4,0 | 13,8 | 12,5 | 11,1 | 9,8 | 8,4 | 16,4 | 15,2 | 13,9 | 12,7 | 11,3 | 19,1 | 17,8 | 16,5 | 15,3 | 14,0 |
| outlet air temperature | °C | 7,3 | 10,4 | 14,5 | 18,6 | 22,6 | 11 | 14,5 | 17,9 | 20,8 | 24,2 | 14,6 | 18,2 | 21,8 | 25,3 | 28,9 | 17,4 | 21 | 24,7 | 28,4 | 31,9 | 20,1 | 23,8 | 27,5 | 31,1 | 34,8 |
| water flow | m ³ /h | 0,3 | 0,2 | 0,2 | 0,1 | 0,1 | 0,5 | 0,4 | 0,3 | 0,3 | 0,2 | 0,6 | 0,5 | 0,5 | 0,4 | 0,4 | 0,7 | 0,7 | 0,6 | 0,5 | 0,5 | 0,8 | 0,8 | 0,7 | 0,7 | 0,6 |
| pressure drop | kPa | 0,4 | 0,2 | 0,2 | 0,1 | 0,1 | 0,8 | 0,6 | 0,4 | 0,3 | 0,1 | 1,3 | 1,1 | 0,9 | 0,7 | 0,5 | 1,8 | 1,6 | 1,3 | 1,1 | 0,9 | 2,4 | 2,1 | 1,8 | 1,6 | 1,3 |

| GUARD PRO 200W | | | | | | | | | | | | | | | | | | | | | | | | | | |
|--|-------------------|-------|------|------|------|------|-------|------|------|------|------|-------|------|------|------|------|-------|------|------|------|------|-------|------|------|------|------|
| inlet/outlet water temperature | | 50/30 | | | | | 60/40 | | | | | 70/50 | | | | | 80/60 | | | | | 90/70 | | | | |
| inlet air temperature | | 0 | 5 | 10 | 15 | 20 | 0 | 5 | 10 | 15 | 20 | 0 | 5 | 10 | 15 | 20 | 0 | 5 | 10 | 15 | 20 | 0 | 5 | 10 | 15 | 20 |
| air flow 9100 m³/h (speed 3) | | | | | | | | | | | | | | | | | | | | | | | | | | |
| heat output | kW | 20,6 | 17,3 | 13,9 | 10,0 | 4,7 | 26,6 | 23,5 | 20,5 | 17,5 | 14,1 | 33,5 | 30,5 | 27,4 | 24,4 | 21,4 | 39,7 | 36,7 | 33,7 | 30,7 | 27,6 | 46,0 | 42,9 | 39,9 | 36,9 | 33,9 |
| outlet air temperature | °C | 6,6 | 10,6 | 14,5 | 18,2 | 21,5 | 8,5 | 12,6 | 16,6 | 20,6 | 24,5 | 10,8 | 14,8 | 18,8 | 22,8 | 26,9 | 12,8 | 16,8 | 20,8 | 24,9 | 28,9 | 14,8 | 18,8 | 22,8 | 26,9 | 30,9 |
| water flow | m ³ /h | 0,9 | 0,8 | 0,6 | 0,4 | 0,2 | 1,2 | 1,0 | 0,9 | 0,8 | 0,6 | 1,5 | 1,3 | 1,2 | 1,1 | 0,9 | 1,7 | 1,6 | 1,5 | 1,3 | 1,2 | 2,0 | 1,9 | 1,8 | 1,6 | 1,5 |
| pressure drop | kPa | 3,4 | 2,5 | 1,7 | 0,91 | 0,2 | 5,4 | 4,3 | 3,4 | 2,5 | 1,7 | 8,2 | 6,9 | 5,6 | 4,5 | 3,6 | 11 | 9,6 | 8,2 | 6,9 | 5,7 | 14 | 13 | 11 | 9,6 | 8,2 |
| air flow 5150 m³/h (speed 2) | | | | | | | | | | | | | | | | | | | | | | | | | | |
| heat output | kW | 14,1 | 11,8 | 9,1 | 5,2 | 3,8 | 18,7 | 16,6 | 14,3 | 12,0 | 9,5 | 23,5 | 21,4 | 19,3 | 17,2 | 15,0 | 27,9 | 25,8 | 23,6 | 21,5 | 19,4 | 32,2 | 30,1 | 28,0 | 25,9 | 23,8 |
| outlet air temperature | °C | 8 | 11,6 | 15,1 | 18 | 22,2 | 10,6 | 14,4 | 18,1 | 21,8 | 25,4 | 13,3 | 17,1 | 20,9 | 24,7 | 28,5 | 15,8 | 19,6 | 23,4 | 27,2 | 31 | 18,2 | 22 | 25,8 | 29,6 | 33,4 |
| water flow | m ³ /h | 0,6 | 0,5 | 0,4 | 0,2 | 0,2 | 0,8 | 0,7 | 0,6 | 0,5 | 0,4 | 1,0 | 0,9 | 0,8 | 0,8 | 0,6 | 1,2 | 1,1 | 1,0 | 0,9 | 0,9 | 1,4 | 1,3 | 1,2 | 1,2 | 1,0 |
| pressure drop | kPa | 1,7 | 1,2 | 0,8 | 0,3 | 0,2 | 2,8 | 2,3 | 1,7 | 1,2 | 0,8 | 4,2 | 3,6 | 2,9 | 2,4 | 1,9 | 5,7 | 5,0 | 4,2 | 3,6 | 2,9 | 7,4 | 6,6 | 5,7 | 5,0 | 4,2 |
| air flow 3400 m³/h (speed 1) | | | | | | | | | | | | | | | | | | | | | | | | | | |
| heat output | kW | 10,7 | 8,7 | 5,8 | 4,5 | 3,3 | 14,5 | 12,7 | 10,9 | 9,1 | 6,9 | 18,3 | 16,7 | 15,0 | 13,4 | 11,6 | 21,7 | 20,0 | 18,4 | 16,8 | 15,1 | 25,0 | 23,4 | 21,8 | 20,1 | 18,5 |
| outlet air temperature | °C | 9,1 | 12,4 | 15 | 18,8 | 22,8 | 12,3 | 15,8 | 19,3 | 22,7 | 25,9 | 15,6 | 19,2 | 22,8 | 26,4 | 29,9 | 18,5 | 22,1 | 25,7 | 29,3 | 32,9 | 21,3 | 24,9 | 28,6 | 32,2 | 35,8 |
| water flow | m ³ /h | 0,5 | 0,4 | 0,3 | 0,2 | 0,1 | 0,6 | 0,5 | 0,5 | 0,4 | 0,3 | 0,8 | 0,7 | 0,6 | 0,6 | 0,5 | 0,9 | 0,9 | 0,8 | 0,7 | 0,6 | 1,1 | 1,0 | 1,0 | 0,9 | 0,8 |
| pressure drop | kPa | 1 | 0,7 | 0,34 | 0,21 | 0,1 | 1,8 | 1,4 | 1,0 | 0,7 | 0,5 | 2,7 | 2,2 | 1,9 | 1,5 | 1,1 | 3,6 | 3,1 | 2,7 | 2,2 | 1,9 | 4,7 | 4,1 | 3,6 | 3,1 | 2,7 |

6. ELECTRICAL CONNECTION DIAGRAMS

To connect the curtain use a 3-core copper cable of minimal diameter 3x1,5mm² for two curtains (up to 6 fans) or 3x2,5mm² for 3 curtains (up to 9 fans). The electrical installation and connection to the power supply must be done in compliance with the existing regulations and standards for the building industry.

The electric network, to which the device is to be connected, should protect the device against overloading and short circuit. It is necessary to use protective grounding. Any electrical installation works and the connection to supply power must be conducted following the applicable building regulations and standards. The connection of the unit to the power supply must be conducted by a qualified specialist who is familiar with the Manual. The fan's motor is equipped with internal thermal protection against overheating. A power cable and the main switch are not included in the set.

Also, the DOORSTOP door contact switch can be installed; it turns off the GUARD PRO curtain when the door is being closed and the moment the door is being opened the GUARD PRO curtain starts operating accordingly to the parameters set in the control panel of the device.

Fan wiring description

- Ain -0-10V signal - yellow
- GND – ground - blue
- Tach Output – unused - white
- +10V – unused - red
- L – power supply - brown
- N – neutral - blue
- PE – protection – yellow/green

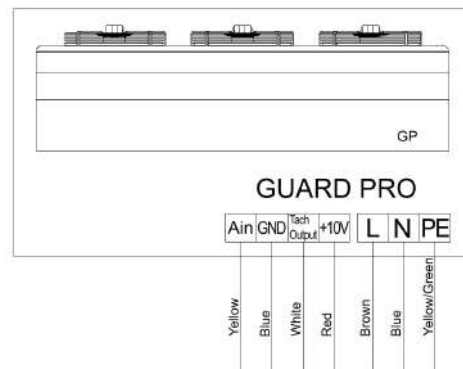

NOTICE!

- ① After a year of operation check the electrical connections and if needed tighten the wire connections to eliminate potential sparking.

6.1. CONNECTION SCHEME FOR GUARD PRO EC TYPE E (ELECTRIC HEATER) WITH THE MULTI 10 EC CONTROL BOX (UP TO 10 UNIT)

Power supply cables not included

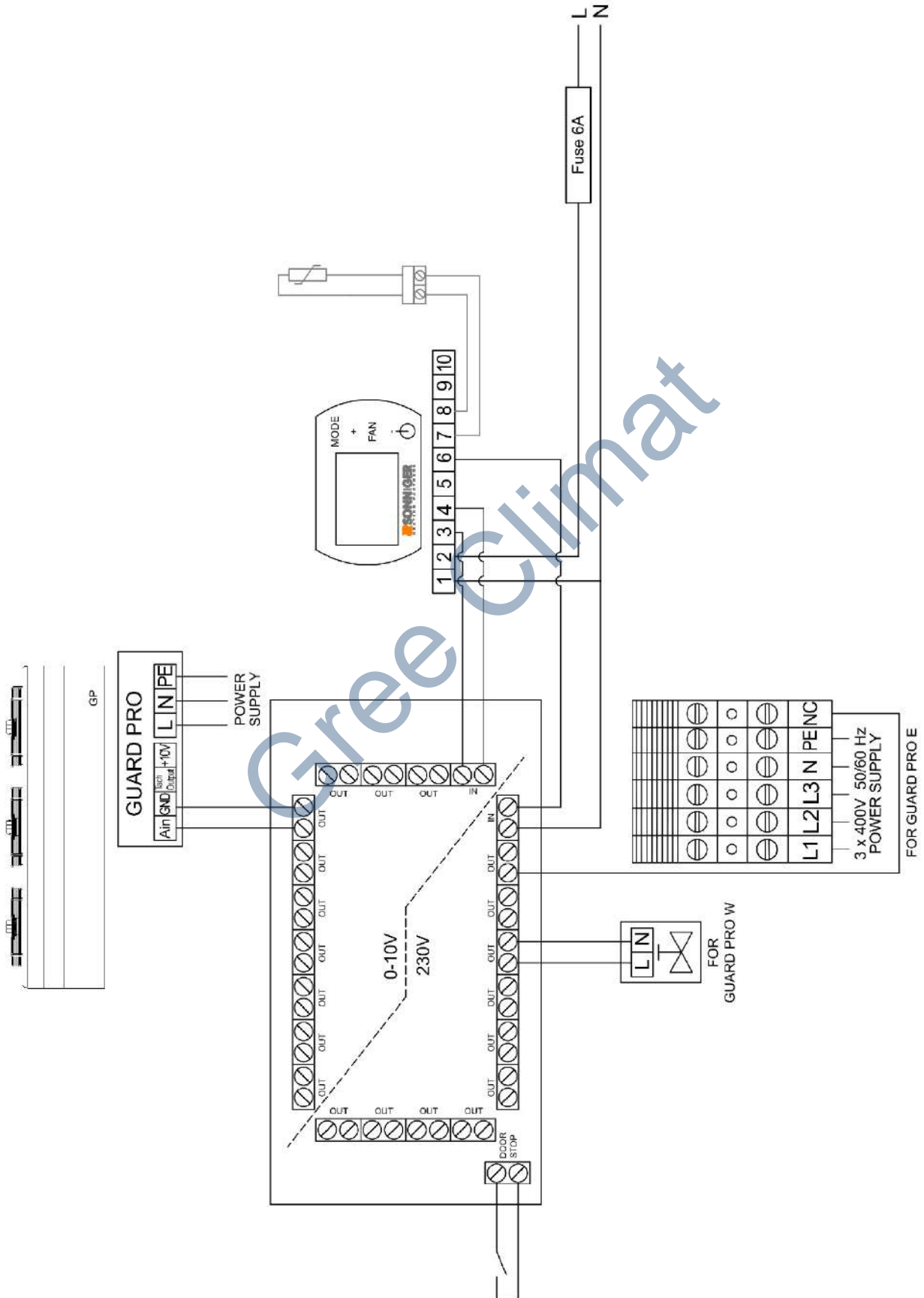

The Multi 10 EC control box allows to connect and control up to 10 GUARD PRO and 10 servomotors. The control of the unit motors is via INTELLIGENT WIFI EC, there is a possibility to connect DOORSTOP switch to it. The thermostat has a primary function when connected to the unit with the Doorswitch.

NOTICE !

- ❶ Power supply for PTC heaters are 3x400V 50/60Hz
- ❶ For GUARDPRO 150E use wire min. 5x6mm², fuse B25
- ❶ For GUARDPRO 200E use wire min. 5x6mm², fuse C32

7. HYDRONIC CONNECTION

Water connections are located at the back of the unit on the right side. Connections should allow access for service and maintenance therefore on both nozzles the shut-off valves should be installed. The order of connecting inlet/outlet pipes does not affect the operation of the exchanger.

8. OPERATION AND MAINTENANCE

The engine and fan used in the GUARD PRO air curtains are maintenance-free devices but regular check-ups are advised, especially motor and bearing (the fan's rotor should rotate freely, free from any axial and radial throws/run-outs and undesired knocks/rattles.

The heat exchanger requires systematical cleaning of all dirt/impurities. Before the start of the heating period, the heat exchanger is advised to be cleaned with compressed air directed to the air outlets; there is no need for dismantling the device.

Pay special attention when cleaning the exchanger's fin due to the high possibility of damaging them. If the fin is bent, use a special tool. If the device has not been used for a longer period, unplug it before the next use.

The heat exchanger is not equipped with any anti-freeze protection device. The heat exchanger may be damaged if the room temperature goes below 0°C.

If the device is to operate in a room where the temperature goes below 0°C, anti-freeze liquid must be added to the water circulation/system. Anti-freeze liquid must be appropriate for the material the exchanger is made of (copper), as well as other elements of the hydraulic system/circulation. The liquid must be diluted with water accordingly to the manufacturer's recommendation.

NOTICE !

- ❶ Any repair and maintenance work must be conducted with the power off and the heat input disconnected.
- ❶ Only suitably qualified staff well acquainted with the safety regulations concerning handling an electrical device must be employed when the device is being installed, started and operated
- ❶ In the event of a coolant leak, when the water system is under pressure, any repairs of the leakage are strictly prohibited.
- ❶ Any repairs to the device must be conducted only if the device is disconnected from the power supply.
- ❶ If the device being operated gives a metallic clatter, or vibration or the level of noise is increasing, check if the mounting of the fan has not become loose – in case of any problems contact the installer of the device or the SONNIGER Authorized Service immediately

9. PANEL INTELLIGENT WIFI EC – programmable controller manual

Panel Intelligent WIFI EC controls actuators/valves and automatically regulates fan's speed depending on the required room temperature. The lower temperature in the room the higher air output is set. Fans speed changes automatically for lower rate, when temperature in a room gets closer to desired one. Intelligent WIFI EC allow to manage works of device via mobile app TUYA SMART.

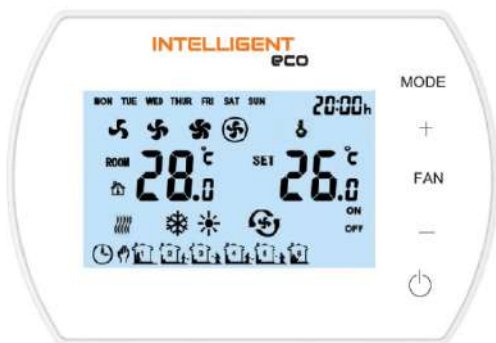

Functions

Panel INTELLIGENT WIFI EC is designed for the SONNIGER products

- Weekly thermostat (5/1/1 days)
- Automatic or manual 3-step fan speed adjustment.
- Control room temperature (by opening/closing the valve, or by adjusting air volume automatically).
- Antifreeze mode- protection against dropping room temperature below critical level 5 ~ 15 °C.
- Possibility to connect external NTC temperature sensor.
- BMS communication by MODBUS protocol
- Wireless control via TUYA SMART app
- Dry contact feedback

Panel description

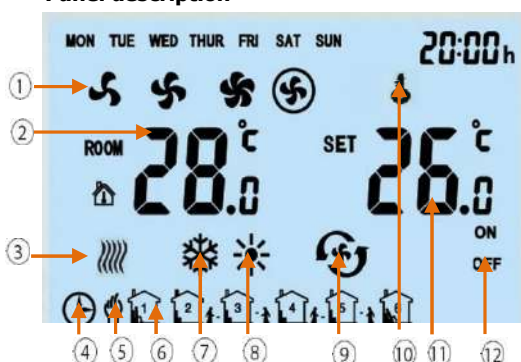

1. Fan Speed: LOW, MED, HI and AUTO
2. ROOM TEMP. or NTC EXTERNAL SENSOR TEMP. (measured temperature)
3. Anti-freeze indication
4. Automatic programmable mode
5. Manual mode
6. 6 Time Zones for each day
7. Cooling Mode
8. Heating Mode
9. Ventilation Mode
10. Buttons Lock
11. SET TEMP. (desired room temperature)
12. ON/OFF status of time zones



13. MODE Press shortly to select manual or automatic mode Press and hold for 3 s and select colling, heating or ventilation mode
14. FAN Press shortly and select fan speed: Low, Med, High or Auto
15. ON/OFF INTELLIGENT Panel

Technical parameters

| | | |
|---|---------------------------|------------------------------------|
| 1 | Power supply | 230VAC/50Hz |
| 2 | Temperature setting range | 5°C 40°C |
| 3 | Temperature working range | -10°C 60°C |
| 4 | IP class | 20 |
| 5 | Temperature sensor | Internal / external NTC (optional) |

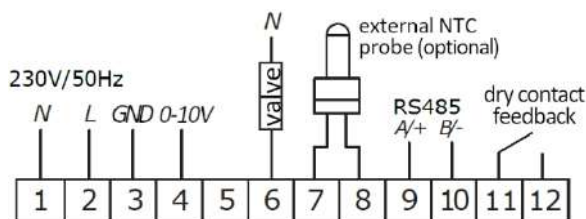

Dimensions

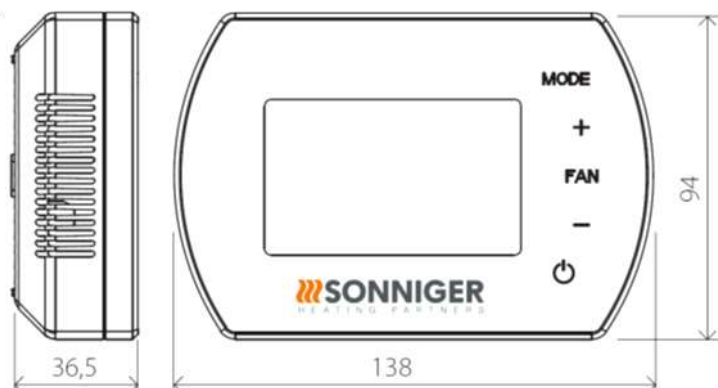

Settings menu

When Panel Intelligent is switched off, press and hold MODE for 5 seconds

To change option use MODE button.

To change value use +/- buttons.

| Setting menu | Option | Value |
|--------------|-------------------------|---|
| 1 | Temperature calibration | -9°C ~ +9°C |
| 2 | EEPROM | 0: 1: memory |
| 3 | Fan status | C1: Thermostatic mode C2: Continuous mode |
| 4 | Temperature sensor | 0: Internal Sensor 1: External Sensor NTC (optional) |
| 5 | Antifreeze | 0: Off 1: On |
| 6 | Antifreeze range | +5°C ~ +15°C |
| 7 | ALARM | 0: disable 1: enable |
| 8 | Drycontact | 0: NO 1: NC |
| 9 | MODBUS | 0: disable 1: enable |
| 10 | BMS speed | 0-2400 / 1-9600 / 2-19200 |
| 11 | Modbus ID | 1~247 (01~F7) |

Button lock / unlock

To LOCK buttons press and hold + and then – and hold both of them for 5 seconds.

To UNLOCK buttons press and hold + and then – and hold both of them for 5 seconds.





Press MODE

Change on manual mode  or automatic mode 

Hold MODE for 5 seconds

Change to cool mode , heating mode , ventilation 







Press FAN

Change of the fan speed low , medium , high , automatyczna 

Hold FAN for 5 seconds







Manual calendar programming Monday – Friday, Saturday, Sunday 6 settings per day

BMS Functions

-  Setting/Reading work parameters
-  Work/Stop conditions
-  Weekly program
-  Temperature
-  Fan speed
-  Heating, ventilation, cool mode
-  Antifreeze mode

| No. | Setting | Parameters |
|-----|--------------------|--|
| 1 | Working Mode | RS485 Semi-duplex; PC or main controller is master; thermostat is slave |
| 2 | Interface | A(+),B(-), 2 wires |
| 3 | Baud Rate | 0-2400 / 1-9600 / 2-19200 |
| 4 | Byte | 9 bits in total: 8 data bit + 1 stop bit |
| 5 | Modbus | RTU Mode |
| 6 | Transmission | RTU (Remote Terminal Unit) format (please refer to MODBUS instruction) |
| 7 | Thermostat address | 1–247 ; (0 is broadcast address and stand for all thermostat without response) |

WIFI functions

-  Setting/Reading work parameters
-  Work/Stop conditions
-  Weekly program
-  Temperature
-  Fan speed
-  Heating, ventilation, cool mode

CONNECTION OF THE PANEL INTELLIGENT WIFI WITH THE TUYA APPLICATION

1. Download the Tuya Smart app (available at App Store and Google Play)
2. The Control panel connects to the power supply and device, Panel INTELLIGENT should stay off
3. Turn on the Tuya app and follow the instruction in the app
4. For the connection process, please enable the GPS and Bluetooth in the phone
5. To activate the pairing mode in the INTELLIGENT Panel tap twice and hold the "+" symbol for 5 seconds until the "SA" symbol shows on the left side of the screen
6. Choose the „Add device" function, and the app should find the control panel automatically, press the "Add" button, and after completing the configuration process, press "Next" and "Finished"
7. In the absence of the "Add" function, select the "Small devices" tab and the "Thermostat (Wi-Fi)" function. After that enter the data to connect to the selected WiFi network and confirm, and then "Blink slowly".
8. A screen will be displayed with information about searching for a device. After detecting the driver, the connection process is automatic. after completing the configuration process, press "Next" and "Finished"

SPARE PARTS CATALOGUE

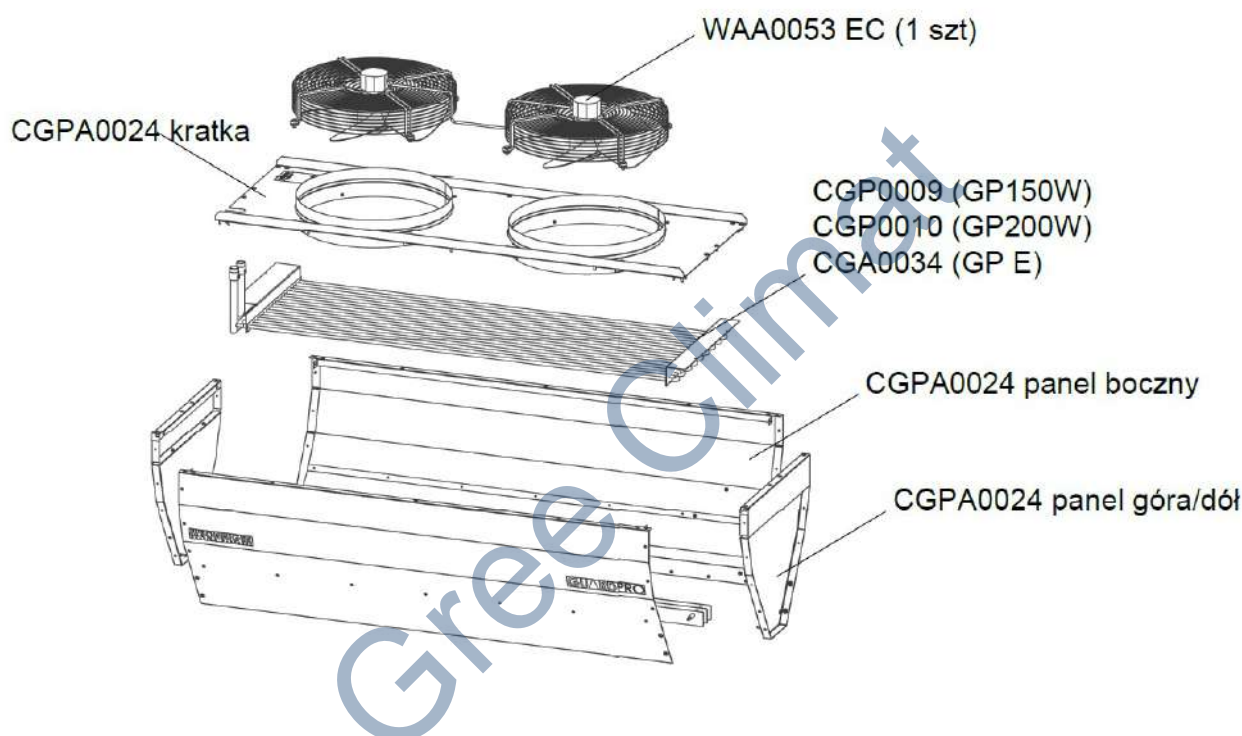

COMPLIANCE WITH WEEE 2012/19 / EU

In accordance with applicable legal regulations, at the time of purchasing new electrical or electronic equipment with the following mark:



REMEMBER IT IS FORBIDDEN TO PLACE THE WORN EQUIPMENT WITH OTHER WASTE

For information on the waste collection system of electrical and electronic equipment, please contact your distributor

GUARANTEE TERMS AND CONDITIONS

§1 Guarantee Scope

1. This Guarantee covers material defects of the device which make its functioning impossible. This Warranty does not extend to the installation and maintenance works.
2. The Guarantee for the product sold by the Seller covers 24 months. The guarantee period commences upon the delivery of the device to the Buyer specified in the sales invoice. The warranty covers any parts/components specified in the scope of the delivery.
3. Products delivered by third persons are not guaranteed by this supplier.
4. Devices may be started and serviced only by qualified persons trained in the areas of maintenance and operation of the device. Any operations related to starting, maintenance, and repairs must be noted that such operations have occurred in the Guarantee Card.
5. The precondition for issuing the Guarantee by the manufacturer is the assembly and activation of the device following the Operation and Maintenance Documentation not later than 6 months after the date of the purchase.
6. The product is guaranteed for a full period of warranty only if service works implied in the Operation and Maintenance Documentation for the device specified in the 'Maintenance' section are carried out. All services related to the maintenance of the device are carried out at the User's cost and expense.
7. The provision of warranty services does not cease or suspend the duration of the Warranty. The warranty for replaced or repaired parts/elements shall end with the expiry of the Guarantee for the device.

§2 Warranty Exclusions/Disclaimers

1. The Warranty does not extend to the mechanical damages and damages to electrical parts caused by improper use, transport, abnormal voltage, or other damages arising from a product defect. For the above reasons, the Warranty is solely limited to the replacement of parts/components having construction defects that shall be delivered without any additional costs only if the defective part/component has been returned.
2. The Warranty for devices does not apply when technical mistakes occurred during the procedures concerning installation, regulation, and control including any of the following:
 - a) Defects caused by connecting a device to an inappropriately designed ventilation system that allows additional heat loads that do not meet any standards and decrease the efficiency of the heat exchanger.
 - b) Defects caused by connecting to the components or parts that are part of the heating system but have not been delivered by the Seller and whose inappropriate functioning harms the device's functioning.
 - c) Defects caused by connecting spare parts to components that are not original parts.
 - d) Defects incurred by reselling the product by the first buyer/user to another buyer who dismantles/installs the device that was previously installed and operated in a specific building and its conditions.
 - e) Defects caused by improper expertise and insufficient knowledge of the installer and technical staff who, improperly carry out after-sale service of the device
 - f) Defects caused by special conditions of use that differ from typical/standard applications unless the parties (the Seller and customer's technical staff) have previously agreed otherwise in writing.
 - g) Defects incurred by natural disasters such as fire, explosions, and other incidents that may result in damages to mechanical, electrical, and protection devices
 - h) Defects are caused by inappropriate cleaning of the technical facility or place where the device has been installed; cleaning must take place periodically to suit the specific working conditions and the amount of dust.
 - i) Defects arisen from the absence or improper cleaning of heat exchangers; cleaning must be done periodically to suit the specific working conditions and the amount of dust.
 - j) Defects incurred by the inappropriate installation - inadequate for the low outside temperature of working conditions.
 - k) Defects incurred by the low temperature if no protection device is installed by the installing contractor to avoid:
 - low temperatures on electrical and mechanical parts such as valves, electric and electronic controlling devices,
 - water condensation and frost/ice near the device,
 - thermal shock of the heater and heat exchanger caused by sudden changes of the outside temperature.

§3 SONNIGER is not liable to:

1. Current maintenance works, and inspections follow from Operation and Maintenance Documentation and device programming.
2. Defects caused by banking of a device while waiting for the warranty service.
3. Any defects caused to the company's property.

§4. Complaint Procedure

1. In the event of a complaint under the Warranty conditions, the user may complain directly to the Distributor.
2. All repairs covered by the warranty shall be done as part of the activity of an installation company and Factory Service. All repairs ensuing from the guarantee shall be done in a place where the device is installed.
3. Any services under the Warranty are to be carried out within 14 days from the date of request. In exceptional cases, the deadline may be extended, especially if the warranty service requires ordering parts or components from subcontractors.
4. The user concerning the service activities is obliged to

Operation and Maintenance Documentation of air curtains GUARD PRO EC v202301

- Allow having full access to the rooms where the devices were installed and provide the necessary facilities allowing direct access to the device (lift, scaffolding, etc.) to do all the servicing covered by the guarantee.
 - Present the original of the Guarantee Card and VAT invoice recording the purchase,
 - Ensure safety while doing the servicing,
 - Allow starting works immediately after the arrival of the Service.
5. In order to make a complaint under the warranty it is necessary to deliver to the Distributor's address the following documents:
 - a) correctly filled-in complaint form that is available at the website of www.sonniger.com
 - b) copy of the Guarantee Card
 - c) copy of the proof-of-purchase - the sales invoice
 6. The repair service including the replacement of the parts shall be done free of charge only if the representative of the installing contractor or the Service claims that the defect or malfunctioning of the device is caused by the fault of the producer.
 7. Any costs (cost of repair, travel, and exchanged components) incurred due to the unjustified complaint, especially in the situation when the representative of the Installing Contractor of the Factory Repair Service claims that defect/damage was caused as a result of breaching the guidelines provided in the Operation and Maintenance Documentation or notices the exclusions under §2 (Warranty exclusions) will be requested from the Buyer/Customer who reported the failure.
 8. The Claimant is obliged to give a written confirmation of the service provided.
 9. Sonniger Poland is entitled to refuse the warranty service if Sonniger Poland has not received full payment for the product complained about under the Guarantee or any previous servicing activities.

Gree Climat

