



Owner's Manual

Original Instructions

Air Conditioners

U-Match Series Duct Type Unit

Models:

Indoor Unit

GU50P/A1-K

GU71P/A1-K

GU85P/A1-K

GU100PH/A1-K

GU125PH/A1-K

GU140PH/A1-K

GU160PH/A1-K

GU50PS/A1-K

GU71PS/A1-K

GU85PS/A1-K

GU100PHS/A1-K

GU125PHS/A1-K

GU140PHS/A1-K

GU160PHS/A1-K

Outdoor Unit

GU50W/A1-K

GU71W/A1-K

GU85W/A1-K

GU100W/A1-M

GU125W/A1-M

GU140W/A1-M

GU160W/A1-M

Thank you for choosing air conditioners. Please read this Owner's Manual carefully before operation and retain it for future reference.

If you have lost the Owner's Manual, please contact the local agent or visit www.gree.com or send an email to global@gree.com.cn for the electronic version.

GREE ELECTRIC APPLIANCES, INC. OF ZHUHAI



To Users

Thank you for selecting Gree's product. Please read this instruction manual carefully before installing and using the product, so as to master and correctly use the product. In order to guide you to correctly install and use our product and achieve expected operating effect, we hereby instruct as below:

- (1) This appliance can be used by children aged from 8 years and above and persons with reduced physical, sensory or mental capabilities or lack of experience and knowledge if they have been given supervision or instruction concerning use of the appliance in a safe way and understand the hazards involved. Children shall not play with the appliance. Cleaning and user maintenance shall not be made by children without supervision.
- (2) In order to ensure reliability of product, the product may consume some power under stand-by status for maintaining normal communication of system and preheating refrigerant and lubricant. If the product is not to be used for long, cut off the power supply; please energize and preheat the unit in advance before reusing it.
- (3) Please properly select the model according to actual using environment; otherwise it may impact the using convenience.
- (4) This product has gone through strict inspection and operational test before leaving the factory. In order to avoid damage due to improper disassembly and inspection, which may impact the normal operation of unit, please do not disassemble the unit by yourself. You can contact with the special maintenance center of our company if necessary.
- (5) When the product is faulted and cannot be operated, please contact with our maintenance center as soon as possible by providing the following information.
 - 1) Contents of nameplate of product (model, cooling/heating capacity, product No., ex-factory date).
 - 2) Malfunction status (specify the situations before and after the error occurs).
- (6) All the illustrations and information in the instruction manual are only for reference. In order to make the product better, we will continuously conduct improvement and innovation. We have the right to make

necessary revision to the product from time to time due to the reason of sales or production, and reserve the right to revise the contents without further notice.

- (7) Indoor unit must not be installed in a laundry.
- (8) If the supply cord is damaged, it must be replaced by the manufacturer, its service agent or similarly qualified persons in order to avoid a hazard.
- (9) Gree Electric Appliances Inc. of Zhuhai assumes no responsibility for personal injury, property loss or equipment damage caused by improper installation and commissioning, unnecessary maintenance, or not following relevant national rules and regulations, industrial standards and requirements in this instruction manual.
- (10) The final right to interpret for this instruction manual belongs to Gree Electric Appliances Inc. of Zhuhai.

Exception Clauses

Manufacturer will bear no responsibilities when personal injury or property loss is caused by the following reasons:

- (1) Damage the product due to improper use or misuse of the product;
- (2) Alter, change, maintain or use the product with other equipment without abiding by the instruction manual of manufacturer;
- (3) After verification, the defect of product is directly caused by corrosive gas;
- (4) After verification, defects are due to improper operation during transportation of product;
- (5) Operate, repair, maintain the unit without abiding by instruction manual or related regulations;
- (6) After verification, the problem or dispute is caused by the quality specification or performance of parts and components that produced by other manufacturers;
- (7) The damage is caused by natural calamities, bad using environment or force majeure.

Contents

1 Safety Notices (Please Be Sure To Abide)	1
2 Product Introduction	5
2.1 Overall Layout.....	5
2.2 Product Operating Range	6
2.3 Standard Accessories	6
3 Installation	7
3.1 Installation Preparation	7
3.2 Unit Installation	15
3.3 Electrical Installation	33
3.4 Check after Installation	42
3.5 Test Running	43
4 Installation of Controller	44
5 Troubleshooting and Maintenance	44
5.1 Failures Not Caused by Faults of the AC	44
5.2 Error Code	45
5.3 Unit Maintenance	46
5.4 After-Sales Services.....	47

This marking indicates that this product should not be disposed with other household wastes throughout the EU. To prevent possible harm to the environment or human health from uncontrolled waste disposal, recycle it responsibly to promote the sustainable reuse of material resources. To return your used device, please use the return and collection systems or contact the retailer where the product was purchased. They can take this product for environmental safe recycling.



1 Safety Notices (Please Be Sure To Abide)

SPECIAL WARNING:

- (1) Do not pierce or burn.
- (2) Do not use means to accelerate the defrosting process or to clean, other than those recommended by the manufacturer.
- (3) Be aware that refrigerants may not contain an odor.
- (4) The appliance shall be stored in a room without continuously operating ignition sources (for example: open flames, an operating gas appliance or an operating electric heater).



PROHIBITED: This sign indicates that the operation must be prohibited. Improper operation may cause severe damage or death to people.



WARNING: If not abide strictly, it may cause severe damage to the unit or the people.



NOTICE: If not abide strictly, it may cause slight or medium damage to the unit or the people.



OBSERVED: This sign indicates that the items must be observed. Improper operation may cause damage to people or property.



WARNING!

This product can't be installed at corrosive, inflammable or explosive environment or the place with special requirements, such as kitchen. Otherwise, it will affect the normal operation or shorten the service life of the unit, or even cause fire hazard or serious injury. As for above special places, please adopt special air conditioner with anti-corrosive or anti-explosion function.

Please read this operating manual carefully before operating the unit.



Before using the air conditioner, please read the instruction manual.



Before installing the air conditioner, please read the instruction manual.

Before repairing the air conditioner, please read the instruction manual.



The figures in this manual may be different with the material objects, please refer to the material objects for reference.



PROHIBITED

- (1) The air conditioner should be grounded to avoid electric shock. Do not connect the ground wire to gas pipe, water pipe, lightning arrester or telephone wire.
- (2) The appliance shall be stored in a well-ventilated area where the room size corresponds to the room area as specified for operation.
- (3) The appliance shall be stored in a room without continuously operating open flames (for example an operating gas appliance) and ignition sources (for example an operating electric heater).
- (4) According to federal/state/local laws and regulations, all packages and transportation materials, including nails, metal or wooden parts, and plastic packing material, must be treated in a safe way.



WARNING

- (1) Please install according to this instruction manual. Installation must be performed in accordance with the requirement of NEC and CEC by authorized personnel only.
- (2) Any person who is involved with working on or breaking into a refrigerant circuit should hold a current valid certificate from an industry-accredited assessment authority, which authorizes their competence to handle refrigerants safely in accordance with an industry, recognized assessment specification.
- (3) Servicing shall only be performed as recommended by the equipment manufacturer.
- (4) The appliance shall be installed in accordance with national wiring regulations.
- (5) The fixed wires connecting to the appliance must be configured with all-pole disconnection device under voltage grade III according to wiring rules.
- (6) Air conditioner should be stored with protective measures against mechanical damage caused by accident.
- (7) If the installation space for air conditioner pipe is too small, adopt a protective measure to prevent the pipe from physical damage.
- (8) During installation, use the specialized accessories and components, otherwise water leakage, electric shock or fire hazard may occur.
- (9) Please install the air conditioner in a secure place that can withstand the weight of air conditioner. Insecure installation may cause the air conditioner falling down and lead to injury.
- (10) Be sure to adopt independent power circuit. If the power cord is damaged, it must be repaired by the manufacturer, service agent or other professional agents.

**WARNING**

- (11) The air conditioner can be cleaned only after it is turned off and power-disconnected, otherwise electric shock may occur.
- (12) The air conditioner is not intended to be cleaned or maintained by children without supervision.
- (13) Do not alter the setting of pressure sensor or other protective devices. If the protective devices are short-circuited or changed against rules, fire hazard or even explosion may occur.
- (14) Do not operate the air conditioner with wet hands. Do not wash or sprinkle water on the air conditioner, otherwise malfunction or electric shock will occur.
- (15) Do not dry the filter with naked flame or an air blower; otherwise the filter will be out of shape.
- (16) If the unit is to be installed in a small space, please adopt protective measures to prevent the concentration of refrigerant from exceeding the allowable safety limit; excessive refrigerant leakage may lead to explosion.
- (17) When installing or re-installing the air conditioner, please keep the refrigerant circuit away from substances other than the specified refrigerant, such as air. Any presence of foreign substances will cause abnormal pressure change or even explosion, resulting in injury.

**NOTICE**

- (1) Do not put a finger or other objects into the air inlet or air return grill.
- (2) Please adopt safety protection measures before touching the refrigerant pipe; otherwise your hands may be hurt.
- (3) Please arrange the drain pipe according to the instruction manual.
- (4) Never stop the air conditioner by directly cutting off the power.
- (5) Please select the proper copper pipe according to the requirement for pipe thickness.
- (6) Indoor unit can only be installed indoors while outdoor unit can be installed either indoors or outdoors. Never install the air conditioner in the following places:
- Places with oil smoke or volatile liquid: plastic parts may deteriorate and fall off or even cause water leakage.
 - Places with corrosive gas: copper pipe or the welding parts may be corroded and cause refrigerant leakage.
- (7) Adopt proper measures to protect the outdoor unit from small animals because they may damage the electric components and cause malfunction of the air conditioner.



OBSERVED

- (1) If wired control is to be used, it should be connected first before powering up the unit, otherwise the wired control may not be able to use.
- (2) When installing the indoor unit, keep it away from television, wireless waves, and fluorescent.
- (3) Only use soft dry cloth or slightly wet cloth with neutral detergent to clean the casing of the air conditioner.
- (4) Before operating the unit under low temperature, connect it to power for 8 hours. If it is stopped for a short time, for example, one night, do not cut off the power (This is to protect the compressor).



WARNING

- (1) Only professionals are allowed to carry on daily maintenance.
- (2) Before contacting any wire, make sure power is cut off.
- (3) Do not let any inflammable objects near the unit.
- (4) Do not use organic solvent to clean the air conditioner.
- (5) If you need to replace a component, please ask a professional to repair with a component supplied by the original manufacturer so as to ensure the unit's quality.
- (6) Improper operation may get the unit broken, hit by electric shock or cause fire.
- (7) Do not make the air conditioner wet or electric shock may be lead; ensure that the air conditioner will not be cleaned by water rinsing under any circumstance.



NOTICE

- (1) Before cleaning, please make sure the unit is stopped. Cut the circuit breaker and remove the power socket, otherwise, electric shock may occur.
- (2) Do not wash the air conditioner with water, otherwise fire hazard or electric shock may occur.
- (3) When cleaning the filter, please be careful of your steps. If you need to work high above the ground, please be extremely careful.

2 Product Introduction

2.1 Overall Layout

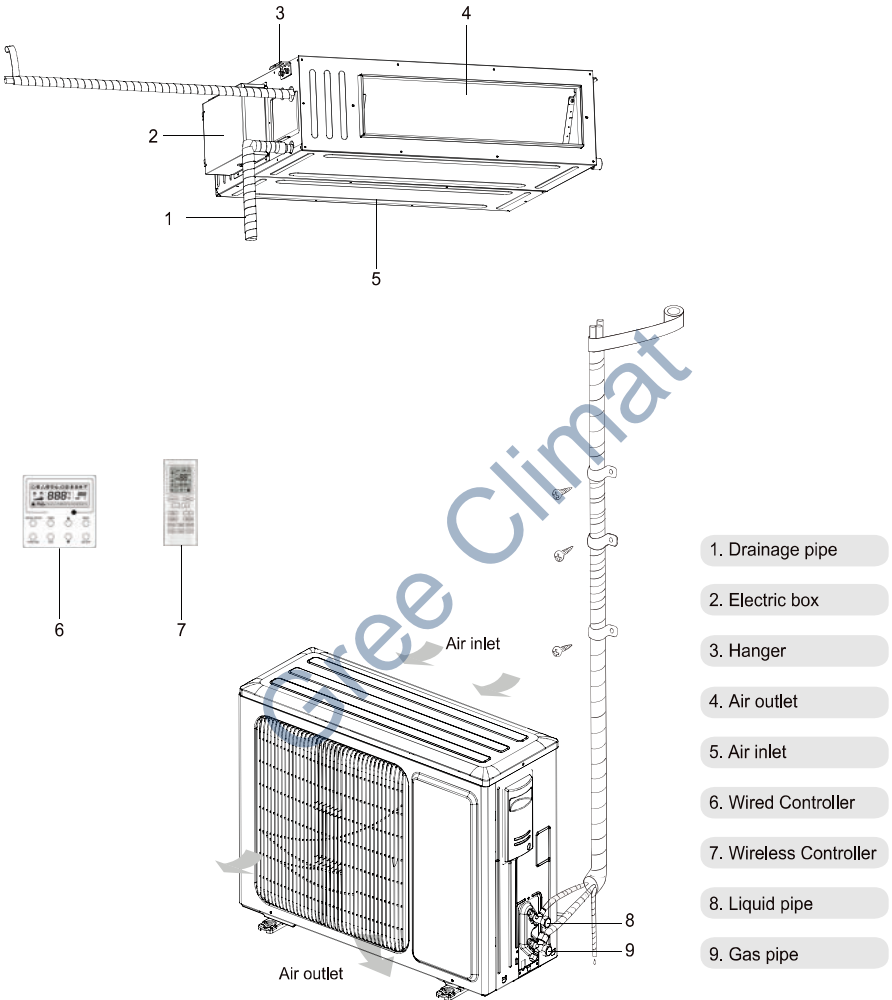













NOTICE:



- (1) The connection pipe, drain pipe, power cord, and duct for this unit should be prepared by the user.
- (2) The unit is standard equipped with rectangular duct.
- (3) Remote controller and wired controller are for reference only.

2.2 Product Operating Range

	Cooling	Heating
Outdoor temperature DB(°C)	-15~48	-15~24
Indoor temperature DB/WB(°C) (Maximum)	32/23	27/-

2.3 Standard Accessories

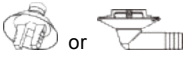
Indoor Unit Accessories				
No.	Name	Appearance	Q'ty	Usage
1	Wired Controller		1	To control the indoor unit
2	Nut with Washer		4	To fix the hook on the cabinet of the unit
3	Nut		4	To be used together with the hanger bolt for installing the unit
4	Washer		4	To be used together with the hanger bolt for installing the unit
5	Insulation		1	To insulate the gas pipe
6	Insulation		1	To insulate the liquid pipe
7	Fastener		8	To fasten the sponge and the Damping Block
8	Sponge		2	To insulate the drain pipe
9	Sponge		1	To insulate the Fresh air inlet
10	Nut		1	To connect gas pipe
11	Nut		1	To connect liquid pipe
12	Connecting Tube Assembly		1	To connect gas pipe(Only Unit 71)

Outdoor Unit Accessories				
No	Name	Appearance	Q'ty	Usage
1	Drain Plug		1or3	To plug the unused drain hole
2	Drainage Connector	 or 	1	To connect with the hard PVC drain pipe

3 Installation

3.1 Installation Preparation

3.1.1 Selection of Installation Location

 WARNING	
①.	The unit must be installed where strong enough to withstand the weight of the unit and fixed securely; otherwise the unit would topple or fall off.
②.	Install the air conditioner at a place where the inclination is less than 5°.
③.	Do not install the unit at a place with direct sunlight.
④.	Do not install where there is the danger of combustible gas leakage.
⑤.	Do not install the unit near heat source of heat, steam, or flammable gas.

Selection of Installation Location for Indoor Unit (Select a location pursuant to the following condition)

- (1) Air inlet and outlet of the indoor unit should be away from obstacles to make sure the unit's air flow can reach the entire room. Do not install the unit in a kitchen or a laundry.
- (2) Select a location that can withstand 4 times the unit weight without increasing operating noise and vibration.
- (3) The installation location must be level.
- (4) The indoor piping length and wiring length should be within the allowable range.
- (5) Select a place that can easily drain condensate and connect to the drain system of the air conditioner.

- (6) If hoisting screw bolts are to be used, check whether the installation location is safe enough. If not safe, reinforce the location before installation.
- (7) Indoor unit, power cord, connecting wires and communication cords should be at least 1m from television and radio. This is to prevent image interference or noise (Even at a distance of 1m, a very strong electric wave may still generate noise).

Selection of Installation Location for Outdoor Unit (Select a location pursuant to the following condition).

- (1) Noise and air flow produced by the outdoor unit will not disturb the neighbors.
- (2) Select a location that is safe and away from animals and plants. If not, please add safety fences to protect the unit.
- (3) Install at a place with good ventilation. Make sure the outdoor unit stays at a well-ventilated place with no obstacles nearby that may obstruct the air inlet and outlet.
- (4) The installation location should be able to withstand the weight and vibration of outdoor unit and allow the installation to be carried out safely.
- (5) Avoid installing at a place with leakage of inflammable gas, oil smoke or corrosive gas.
- (6) Keep it away from strong wind because strong wind will affect the outdoor fan and lead to insufficient air flow volume and thus affecting the unit's performance.
- (7) Install the outdoor unit at a place that is convenient for it to be connected to the indoor unit.
- (8) Away from any object that may get the air conditioner generating noise.
- (9) Install the outdoor unit at a place where condensate can be easily drained.

3.1.2 Unit Dimension



WARNING

- ①. Install the indoor unit in a location which can withstand a load of at least five times the weight of the main unit and which will not amplify sound or vibration.
- ②. If the installation location is not strong enough, the indoor unit may fall and cause injuries.
- ③. If the job is done with the panel frame only, there is a risk that the unit will come loose. Please take care.

1) Indoor Unit

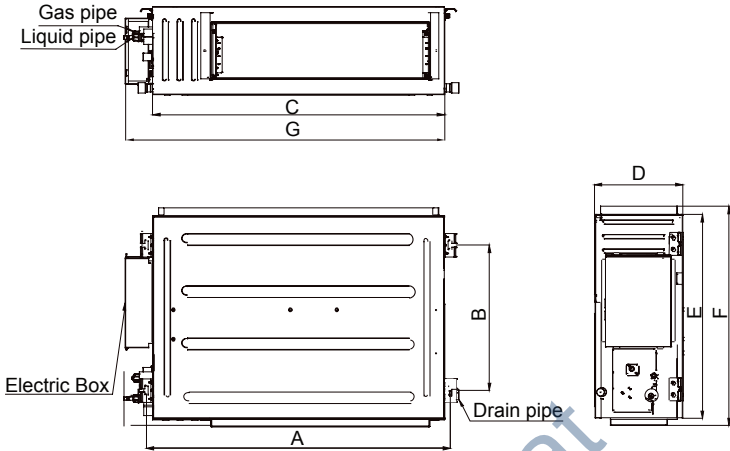

NOTICE

Drilling of ceiling opening and installation of air conditioner must be performed by professionals!

Unit: mm

Model \ Item	A	B	C	D	E	F	G
GU50P/A1-K	1060	415	1000	200	450	474	1068
GU50PS/A1-K							
GU71P/A1-K	1360	415	1300	220	450	474	1368
GU71PS/A1-K							
GU85P/A1-K	1360	415	1300	220	450	474	1368
GU85PS/A1-K							
GU100PH/A1-K	1040	500	1000	300	700	754	1092
GU100PHS/A1-K							
GU125PH/A1-K	1040	500	1000	300	700	754	1092
GU125PHS/A1-K							
GU140PH/A1-K	1440	500	1400	300	700	754	1492
GU140PHS/A1-K							
GU160PH/A1-K	1440	500	1400	300	700	754	1492
GU160PHS/A1-K							

2) Outdoor Unit

GU50W/A1-K; GU71W/A1-K; GU85W/A1-K; GU100W/A1-M

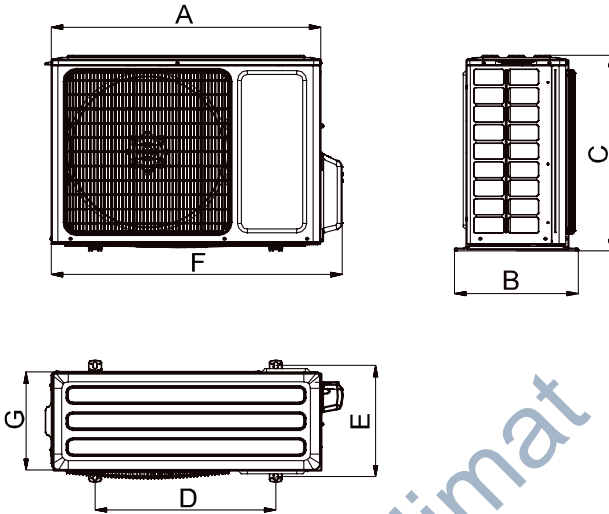

GU125W/A1-M; GU140W/A1-M; GU160W/A1-M

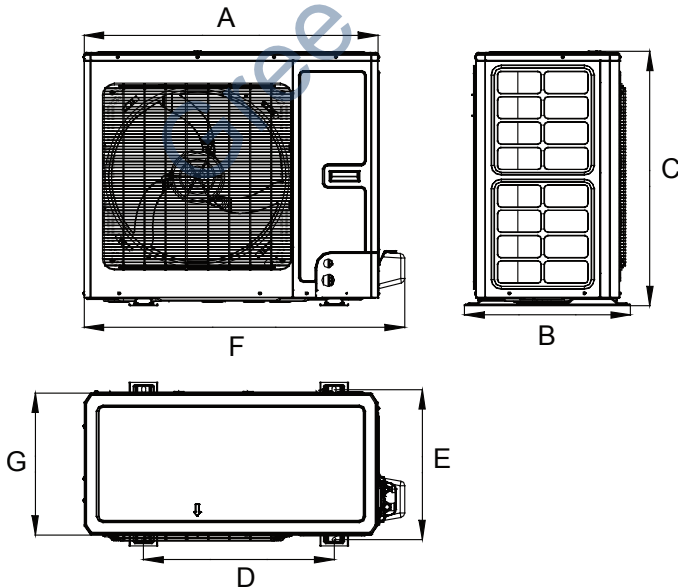

Unit: mm

Dimensions	A	B	C	D	E	F	G
Model							
GU50W/A1-K	761	320	548	540	286	825	256
GU71W/A1-K	892	396	698	560	364	957	340
GU85W/A1-K	892	396	698	560	364	957	340
GU100W/A1-M	920	427	790	610	395	985	370
GU125W/A1-M	940	530	820	610	486	1010	460
GU140W/A1-M	940	530	820	610	486	1010	460
GU160W/A1-M	940	530	820	610	486	1010	460

3.1.3 Diagram of Unit Installation Space and Location

(1) Diagram of installation space and location for outdoor unit (Notice: for best performance of the outdoor unit, make sure its installation space conforms to the following installation dimensions).

1) When one outdoor unit is to be installed.

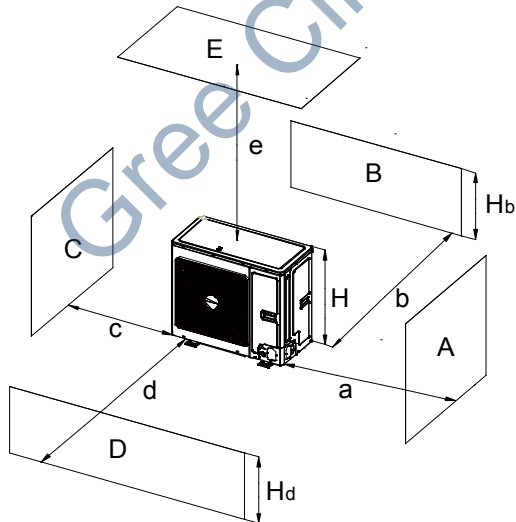

U-Match Series Duct Type Unit

A~E	H _b H _d H		(mm)					
			a	b	c	d	e	
B	—			≥100				
A,B,C,	—		≥300	≥100	≥100			
B,E	—			≥100			≥1000	
A,B,C,E	—		≥300	≥150	≥150		≥1000	
D	—					≥1000		
D,E	—					≥1000	≥1000	
B,D	H _b <H _d	H _d >H		≥100			≥1000	
	H _b >H _d	H _d <H		≥100			≥1000	
B,D,E	H _b <H _d	H _b ≤1/2H		≥250			≥2000	
		1/2H<H _b ≤H		≥250			≥2000	
		H _b >H	Prohibited					
	H _b >H _d	H _d ≤1/2H		≥100			≥2000	≥1000
		1/2H<H _d ≤H		≥200			≥2000	≥1000
		H _d >1/2H	Prohibited					

2) When two or more outdoor units are to be installed side by side.

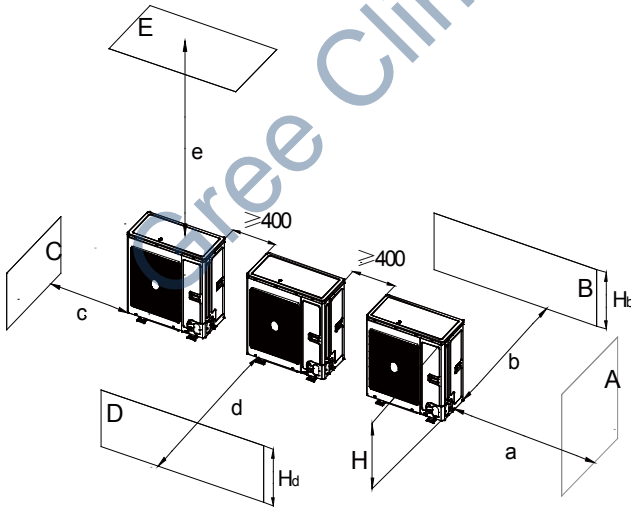

A~E	H _b H _d H		(mm)				
			a	b	c	d	e
A,B,C	—		≥300	≥300	≥1000		
A,B,C,E	—		≥300	≥300	≥1000		≥1000
D	—					≥2000	
D,E	—					≥2000	≥1000

A~E	H_b H_d H		(mm)				
			a	b	c	d	e
B,D	$H_b < H_d$	$H_d > H$		≥ 300		≥ 2000	
	$H_b > H_d$	$H_d \leq 1/2H$		≥ 250		≥ 2000	
$1/2H < H_d \leq H$			≥ 300		≥ 2500		
B,D,E	$H_b < H_d$	$H_b \leq 1/2H$		≥ 300		≥ 2000	≥ 1000
		$1/2H < H_b \leq H$		≥ 300		≥ 2500	≥ 1000
	$H_b > H$	Prohibited					
	$H_b > H_d$	$H_d \leq 1/2H$		≥ 250		≥ 2500	≥ 1000
		$1/2H < H_d \leq H$		≥ 300		≥ 2500	≥ 1000
	$H_d > 1/2H$	Prohibited					

3) When outdoor units are installed in rows.

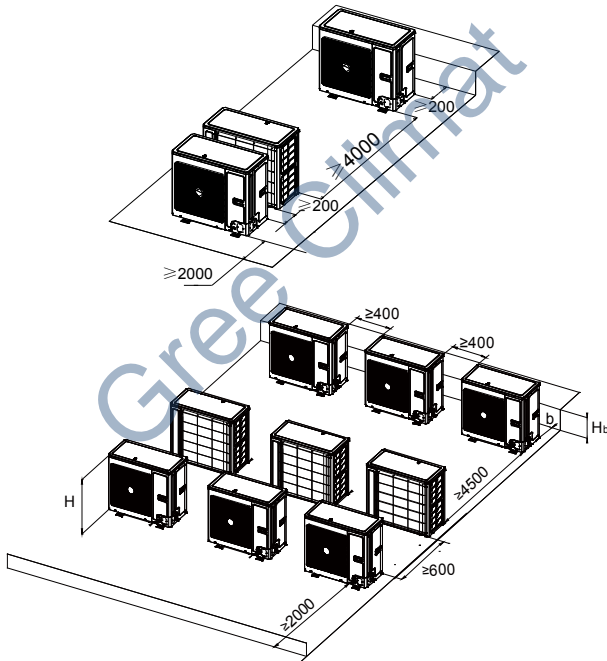

H_b H	(mm)
$H_b \leq 1/2H$	$b \geq 250$
$1/2H < H_b \leq H$	$b \geq 300$
$H_b > H$	Prohibited

4) When outdoor units are installed one above another.

Unit: mm

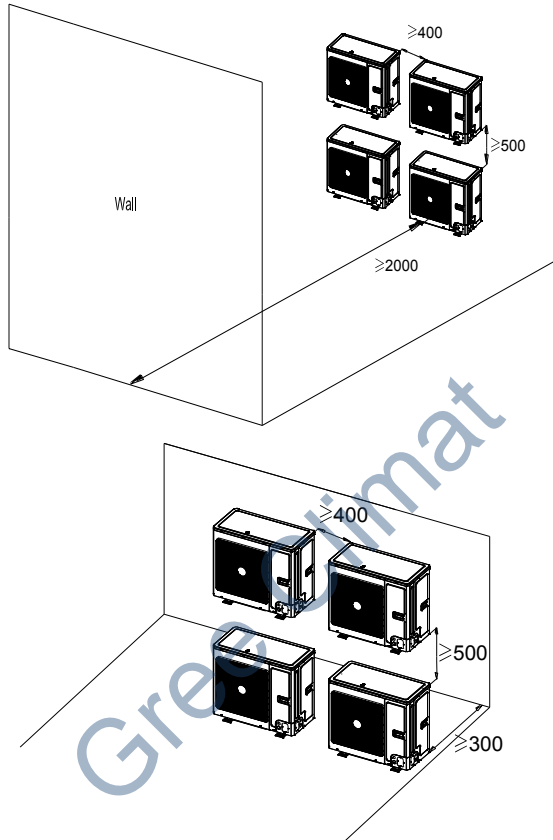

- (2) Diagram of installation location and space for indoor unit (Notice: for the best performance of indoor unit, make sure its installation space conforms to the following installation dimensions).

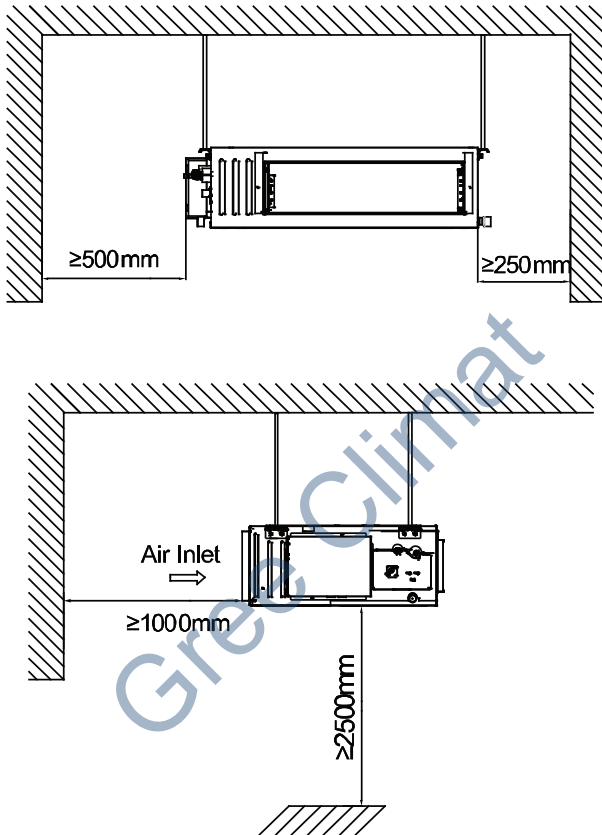

3.2 Unit Installation

3.2.1 Indoor Unit Installation

3.2.1.1 Preparation for Installing the Indoor Unit



NOTICE

- ① Please tighten the nut and bolt to prevent the air conditioner from falling down.
- ② The unit might be loose if fixing the panel rack only. Be careful during installation.

- (1) Install the bolts to the ceiling at a place strong enough to hang the unit. Mark the bolt positions from the installation template. With a concrete drill for 12.7mm diameter holes. See the following figure.

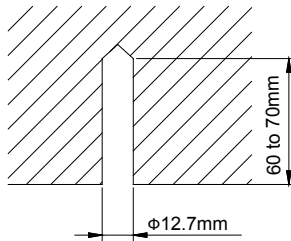

- (2) Insert the anchor bolts into the drilled holes, and drive the pins completely into the anchor bolts with a hammer. See the following figure.

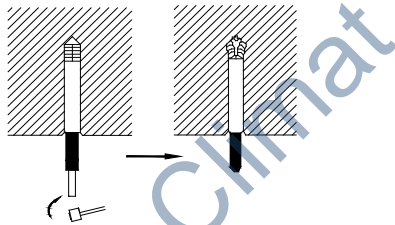

- (3) Install the hanger to the unit. See the following figure.

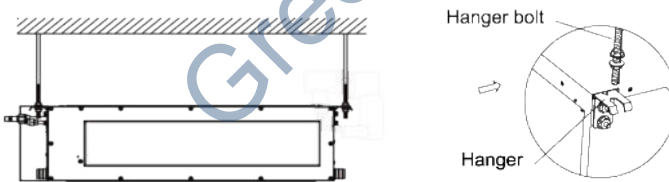

- (4) Pass the unit hangers over the bolts installed to the ceiling and install the unit with the special nut. See the following figure.

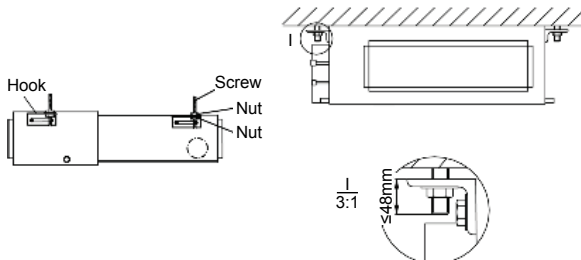

3.2.1.2 Leveling

The water level test must be done after installing the indoor unit to make the unit is horizontal, as shown below.

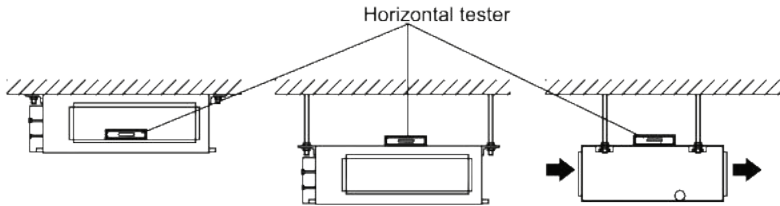

3.2.2 Outdoor Unit Installation

- (1) If the outdoor unit is installed on a solid ground such as concrete, use M10 screw bolts and nuts to secure the unit and make sure the unit stands erect and level.
- (2) Do not install it on top of the building.
- (3) If it vibrates and causes noise, please add rubber cushion between the outdoor unit and the installation base.
- (4) When the outdoor unit is in heating or defrosting, it needs to drain water. When installing the drain pipe, plug the accompanied drainage connector to the drainage hole on the chassis of the outdoor unit. Then connect a drain hose to the drainage connector (If drainage connector is used, the outdoor unit should be at least 10cm from the installation ground). See the following figures.

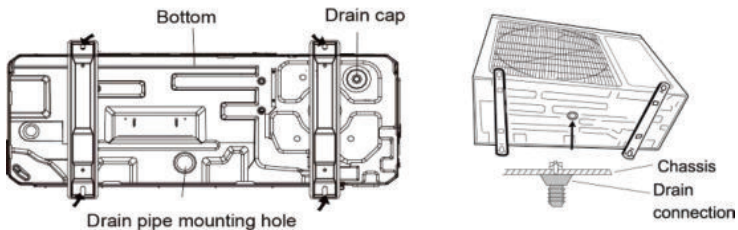

3.2.3 Connection Pipe Requirement

3.2.3.1 Installation Notice and Requirement on Connection Pipe

Installation method: Connect the connection pipes first to the indoor unit and then to the outdoor unit. When bending a connection pipe, be careful not to damage the pipe. Do not over-tighten the screw nut, otherwise leakage will occur. Besides,

U-Match Series Duct Type Unit

the outside of connection pipe should be added with a layer of insulating cotton to protect it from mechanical damage during installation, maintenance and transportation.

Model \ Item	Size of Fitting Pipe (Inch)		Maximum pipe length(m)	Biggest drop between indoor and outdoor units (m)
	Liquid	Gas		
GU50P/A1-K	1/4	1/2	30	15
GU50PS/A1-K				
GU71P/A1-K	3/8	5/8	30	15
GU71PS/A1-K				
GU85P/A1-K	3/8	5/8	30	15
GU85PS/A1-K				
GU100PH/A1-K	3/8	5/8	30	20
GU100PHS/A1-K				
GU125PH/A1-K	3/8	5/8	50	30
GU125PHS/A1-K				
GU140PH/A1-K	3/8	5/8	50	30
GU140PHS/A1-K				
GU160PH/A1-K	3/8	5/8	50	30
GU160PHS/A1-K				

Connection pipe should adopt water-proof insulating material. Its wall thickness should be 0.5-1.0mm and the pipe wall should be able to withstand 6.0MPa. The longer the connection pipe is the worse cooling and heating performance it has.

When the drop between indoor and outdoor units is larger than 10m, an oil return bend should be added every 6 meters.

The requirement on the adding of oil return bend is as below:

(1) Outdoor unit is beneath the indoor unit.

There's no need to add non-return bend at the lowest or highest position of the vertical pipe, as shown below:

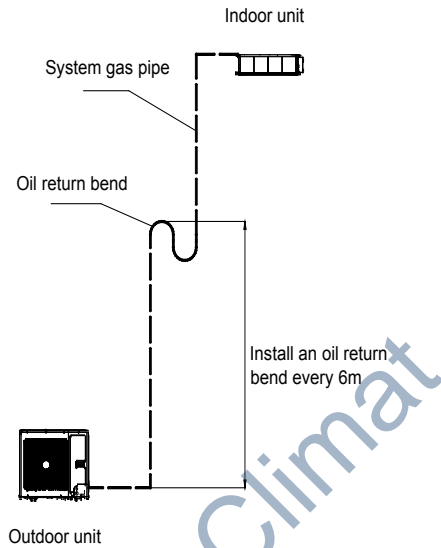

(2) Outdoor unit is above the indoor unit.

It's necessary to add oil return bend and non-return bend at the lowest and highest position of the vertical pipe, as shown below:

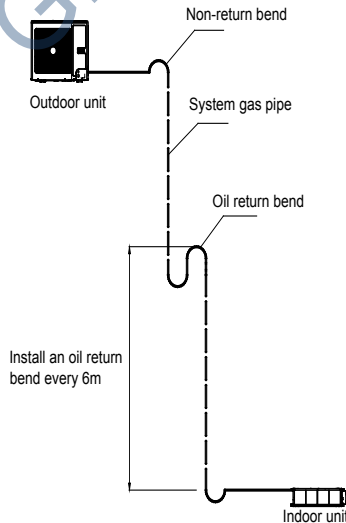

Dimensions for the making of oil return bend are as follows:

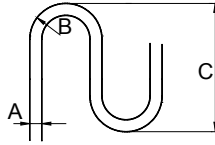

A		B(mm)	C(mm)
mm	In.		
Φ12	1/2	≥26	≤150
Φ16	5/8	≥33	≤150

3.2.3.2 Pipe Flaring

- (1) Cut the connection pipe with a pipe cutter.
- (2) The mouth of connection pipe should face downward. Remove burrs with the cut surface so that the chips do not enter the pipe.
- (3) Take out the flare nut from the bag of indoor unit accessories. Then fit the flare nut on the pipe and use a flaring tool to flare the mouth of connection pipe.
- (4) Check whether the flaring part has cracked (see the figure below).

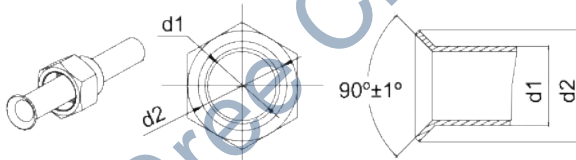

3.2.3.3 Pipe Bending

- (1) The pipes are shaped by your hands. Be careful not to collapse them.

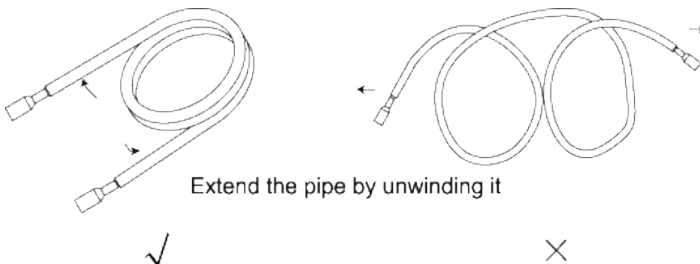

- (2) Do not bend the pipes in an angle more than 90°.
- (3) If the pipe is repeatedly bent or extended, it will become hard and difficult to be bent or extended. So do not bend or extend the pipe for more than 3 times.
- (4) When bending the pipe, do not bend it excessively, otherwise it will get broken.

As shown beside, use a sharp cutter to cut the heat insulating pipe and bend it after the pipe is exposed. After bending, place the heat insulating pipe back on the pipeline and fix it with adhesive tape.

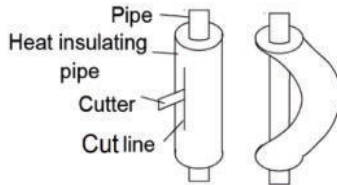

3.2.3.4 Connecting the Pipe at the Indoor Unit Side



NOTICE

- ①. Connect the pipe to the unit. Please follow the instructions stated in the figures below. Use both spanner and torque wrench.
- ②. When connecting the tapered screw nut, first apply chilled machine oil on its inner and outer surface and then screw it up for 3~4 circles.
- ③. Confirm the tightening torque by referring to the following table (If the screw nut is over-twisted, it may be damaged and cause leakage).
- ④. Check whether gas leakage occurs to the connection pipe and then apply thermal insulation, as shown below.
- ⑤. Wind sponge around the joint of gas pipe and heat insulation sheath of gas collecting pipe.
- ⑥. Be sure to connect gas pipe after liquid pipe is connected.

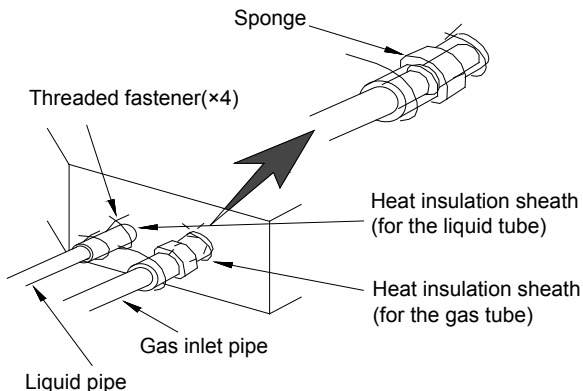

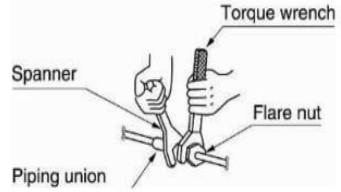
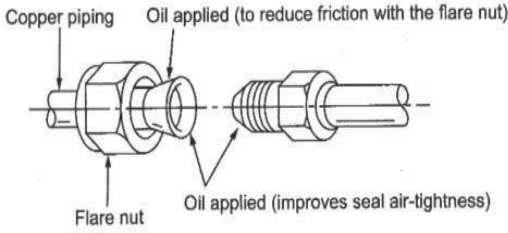

Pipe Diameter(In)	Tightening Torque(N·m)
1/4"	15-30
3/8"	35-40
1/2"	45-50
5/8"	60-65
3/4"	70-75
7/8"	80-85

Screw on the flare nut of the flaring connecting pipe on the outdoor unit valve. The method of screwing the flare nut is the same with that for indoor unit.

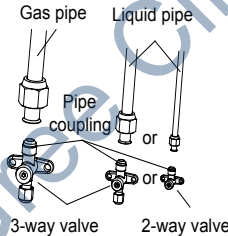

3.2.3.5 Thermal Insulation of Pipe Joint (Only for Indoor Unit)

Stick coupler heat insulation (large and small) to the place where connecting pipes.

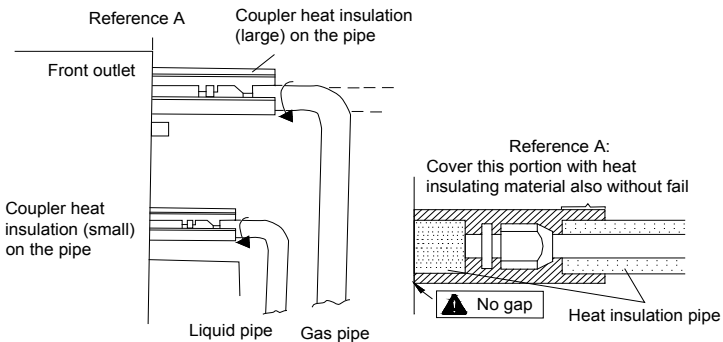

3.2.4 Connection Pipe Vacuum Pumping



NOTICE

Make sure the outlet of vacuum pump is away from fire source and is well-ventilated.

- (1) Remove the caps of the liquid valve, gas valve and also the service port.
- (2) Connect the hose at the low pressure side of the manifold valve assembly to the service port of the unit's gas valve, and meanwhile the gas and liquid valves should be kept closed in case of refrigerant leak.
- (3) Connect the hose used for evacuation to the vacuum pump.
- (4) Open the switch at the lower pressure side of the manifold valve assembly and start the vacuum pump. Meanwhile, the switch at the high pressure side of the manifold valve assembly should be kept closed, otherwise evacuation would fail.
- (5) The evacuation duration depends on the unit's capacity, generally.

Model	Time(min)
GU50W/A1-K	20
GU71W/A1-K GU85W/A1-K GU100W/A1-M	30
GU125W/A1-M GU140W/A1-M GU160W/A1-M	45

And verify if the pressure gauge at the low pressure side of the manifold valve assembly reads -0.1MPa (-75cmHg), if not, it indicates there is leak somewhere. Then, close the switch fully and then stop the vacuum pump.

- (6) Wait for 10min to see if the system pressure can remain unchanged. If the pressure decrease, there may be leakage.
- (7) Slightly open the liquid valve and let some refrigerant go to the connection pipe to balance the pressure inside and outside of the connection pipe, so that air will not come into the connection pipe when removing the hose. Note that the gas and liquid valve can be opened fully only after the manifold valve assembly is removed.
- (8) Place back the caps of the liquid valve, gas valve and also the service port.

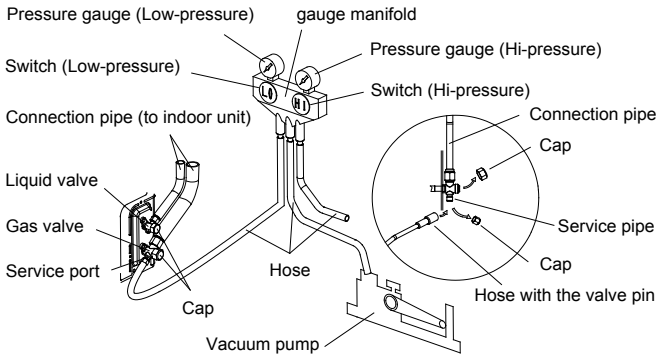

NOTICE:

For large-size units, there are maintenance ports for liquid valve and gas valve. During evacuation, you may connect the two hoses of the branch valve assembly to the maintenance ports to speed up the evacuation.

3.2.5 Refrigerant Adding

See the following table for the amount of additional refrigerant.

Item	Standard Pipe Length	Unnecessary Charge Pipe Length	Additional Refrigerant Amount for Extra Pipe
GU50W/A1-K	5.0m	≤7.0m	22 g/m
GU71W/A1-K	5.0m	≤7.0m	30 g/m
GU85W/A1-K	5.0m	≤7.0m	30 g/m
GU100W/A1-M	5.0m	≤7.0m	45 g/m
GU125W/A1-M	5.0m	≤7.0m	45 g/m
GU140W/A1-M	7.5m	≤9.5m	45 g/m
GU160W/A1-M	7.5m	≤9.5m	54 g/m

3.2.6 Installation of Drain Hose

- (1) It is not allowed to connect the condensate drain pipe into waste pipe or other pipelines which are likely to produce corrosive or peculiar smell to prevent the smell from entering indoors or corrupt the unit.
- (2) It is not allowed to connect the condensate drain pipe into rain pipe to prevent rain water from pouring in and cause property loss or personal injury.
- (3) Condensate drain pipe should be connected into special drain system for air conditioner.

3.2.6.1 Indoor Side Drainage Pipe

**NOTICE**

Install the drain hose in accordance with the instructions in this installation manual and keep the area warm enough to prevent condensation. Problems with the piping may lead to water leaks.

- (1) Install the drain hose with downward gradient (1/50 to 1/100) and no risers or traps are used for the hose. See the following figure.
- (2) Be sure there is no crack or leak on the drain hose to avoid the formation of air pocket. See the following figure.

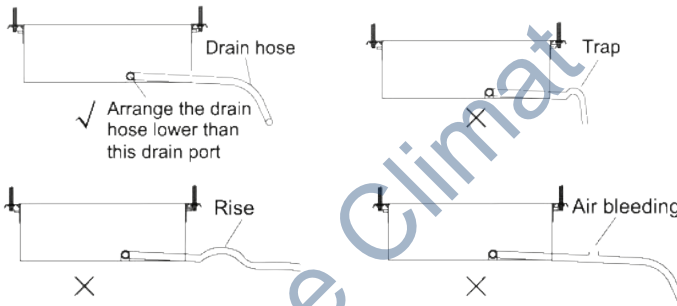

- (3) When the hose is long, install supporters. See the following figure.

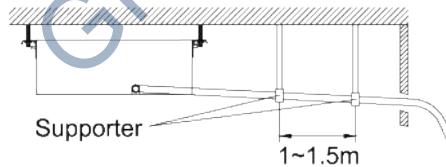

- (4) Always use the drain hose which has been insulated properly.
- (5) Use a suitable drain hose.
- (6) There is a drain port on both the left and right sides. Select the drain port to match the local conditions. See the following figure.

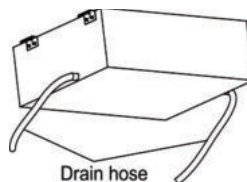

one on the left side (electric box side).

- (8) When using the drain port on the right side of the unit, reinstall the drain cap to the left side drain port. See the following figure.

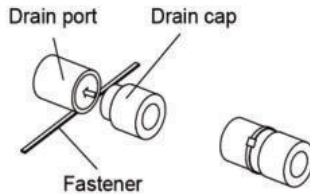

- (9) Be sure to insulate where the drain port and the drain hose is connected. See the following figure.

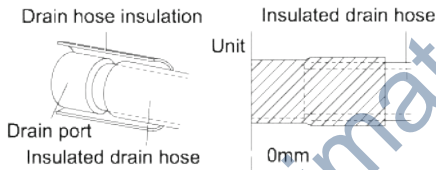

- (10) The unused drain port also should be insulated properly. See the following figure.

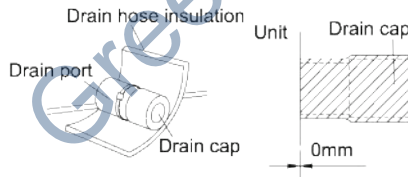

- (11) There is adhesive on one side of the insulation so that after removing the protective paper over it the insulation can be directly attached to the drain hose.

3.2.6.2 Outdoor Side Drainage Pipe

- (1) If the outdoor unit is underneath the indoor unit, arrange the pipeline according to the following diagram.
- 1) Drain hose should be placed on the ground and its end should not be immersed into water. The whole pipeline should be supported and fixed onto the wall.
 - 2) Wind the insulating tape from bottom to top.
 - 3) The whole pipeline should be wound with insulating tape and fixed onto the wall with saddles.

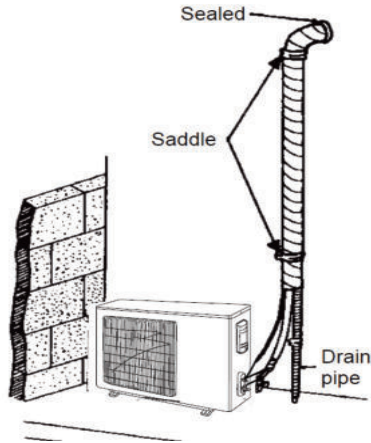

(2) If the outdoor unit is above the indoor unit, arrange the pipeline according to the following diagram.

- 1) Wind the insulating tape from bottom to top.
- 2) The whole pipeline should be wound together to avoid water returning to the room.
- 3) Use saddles to fix the whole pipeline onto the wall.

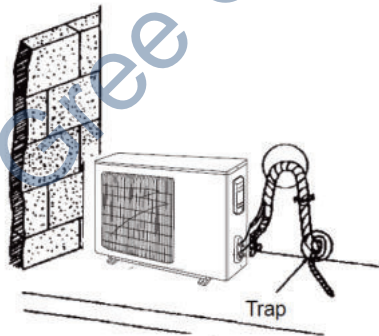

3.2.6.3 Notice on Drain Lift Pipe

- (1) For the unit with the condensate pump, only one drain port at the side close to the electric box is prepared and only through it the drain hose can be connected.

Model \ Item	Drain pipe (outer dimension x wall thickness)(mm)
GU50P/A1-K GU50PS/A1-K	$\Phi 26 \times 2.5$
GU71P/A1-K GU71PS/A1-K	
GU85P/A1-K GU85PS/A1-K	
GU100PH/A1-K GU100PHS/A1-K	
GU125PH/A1-K GU125PHS/A1-K	
GU140PH/A1-K GU140PHS/A1-K	
GU160PH/A1-K GU160PHS/A1-K	

- (2) For the unit with the condensate pump, two drain ports at the bottom are defaulted to be factory plugged with drain caps. After the installation of the drain hose, these two drain ports also need to be insulated properly with the same way aforementioned.
- (3) The lifted installation height of drainage pipe is less than 1000mm, as is shown in the following figure.

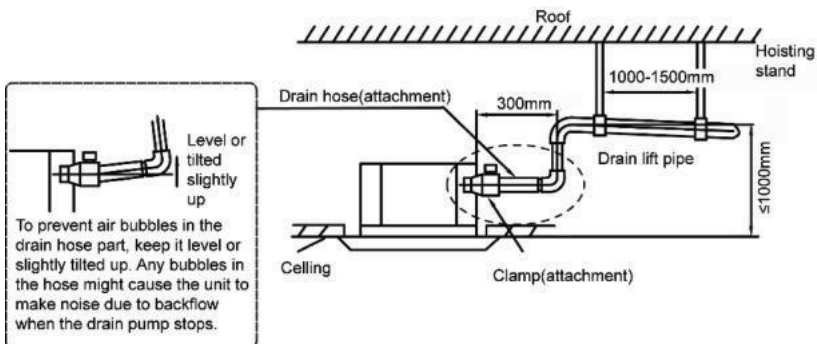

The vertical height of the drain hose should be 75mm or less so that it is unnecessary for the drain port to withstand additional force.

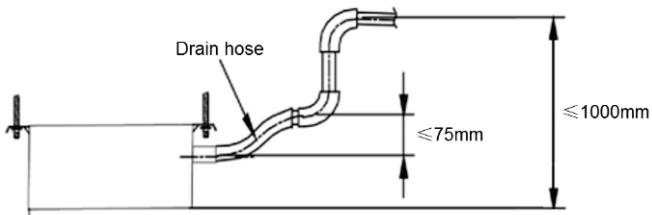

When multiple drain hoses are used, their installation should be performed as shown in the figure below.

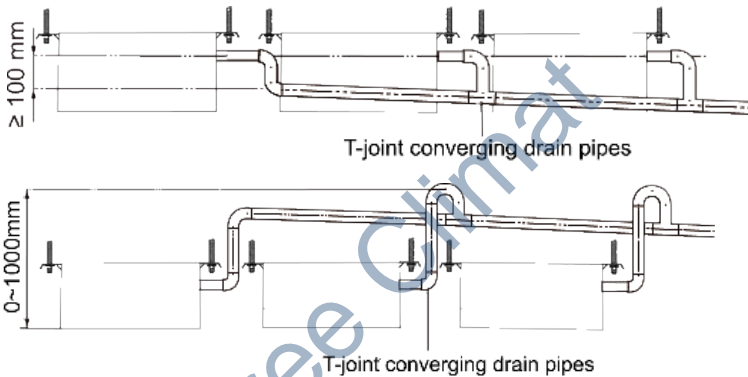

NOTICE:

The specification of the selected merged drainage pipe shall be appropriate for the operation capacity of the unit.

- (1) Drain branch should be connected to the vertical or horizontal part of the main drain pipe.
- (2) Horizontal pipe should not be connected to the vertical pipe that is on the same level. It should be connected in the following way:
 - 1) Attach the 3-way connection of the drainage pipe joint.
 - 2) Attach the drain elbow.
 - 3) Attach the horizontal pipe.

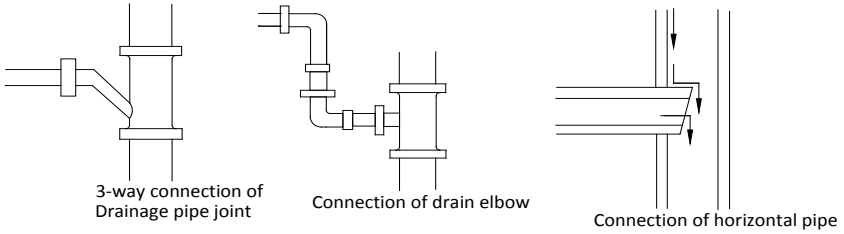

3.2.6.4 Check Drainage

After piping work is finished, check if drainage flows smoothly.

As shown in the figure, add approximately 1liter of water slowly into the drain pan and check drainage flow during COOL running.

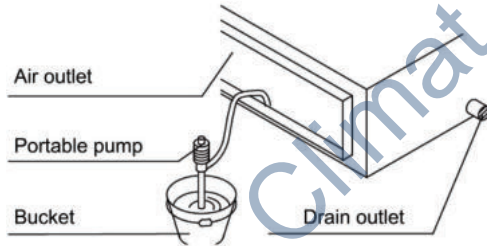

3.2.7 Installation of the Duct

3.2.7.1 Dimensions of the Supply Air Outlet/Return Air Inlet

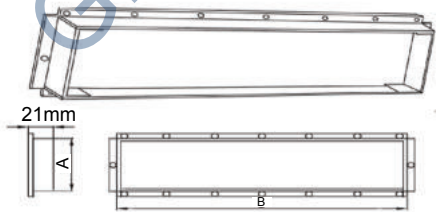

Supply Air Outlet

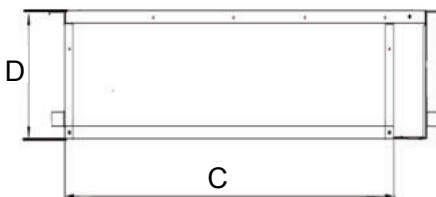

Return Air Inlet

Unit: mm

Model \ Item	Supply Air Outlet		Return Air Inlet	
	A	B	C	D
GU50P/A1-K GU50PS/A1-K	122	885	1000	200
GU71P/A1-K GU71PS/A1-K	142	1185	1300	220
GU85P/A1-K GU85PS/A1-K	142	1185	1300	220
GU100PH/A1-K GU100PHS/A1-K	195	746	960	264
GU125PH/A1-K GU125PHS/A1-K	195	746	960	264
GU140PH/A1-K GU140PHS/A1-K	195	1150	1360	264
GU160PH/A1-K GU160PHS/A1-K	195	1150	1360	264

3.2.7.2 Return Air Method

- (1) The default ex-factory return air method is from the back. The return air cover shall be installed at the bottom of the unit, as is shown in the following figure.

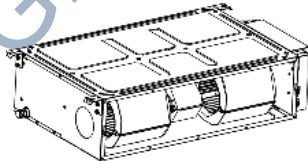

- (2) If the downward return air method is adopted, then install the return air cover at the back of the unit after dismantling it.

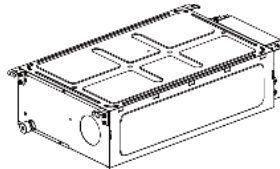

- (3) Connect the return duct to the return air inlet of indoor unit with rivet, and the other side shall be connected to the return air inlet. For the convenience of free height adjustment, canvas duct can be made and reinforced with iron wire to a

- (4) The noise of downward return air is obvious bigger than that of rear return air. For downward return air, silencer and static pressure carton shall be added to conduct noise reduction treatment.

3.2.7.3 Installation of Air Supply Duct and Air Return Supply

Installation method shall be selected by entirely considering the conditions of buildings, maintenance, etc. as is shown in the following figure.

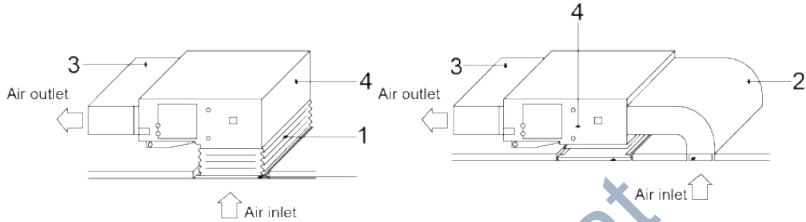

No	1	2	3	4
Name	canvas duct	air return duct	air supply duct	indoor unit

3.2.7.4 Installation of Fresh Air Duct

- (1) While connecting the fresh air duct, cut off the fresh air baffle plate as is shown in the following figure. If the fresh air duct is not used, block the gap of fresh air baffle plate with sponge.

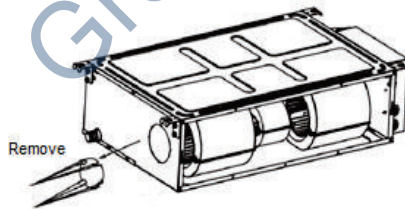

- (2) Install the round flange so that it can be connected to the fresh air duct, as is shown in the following figure.

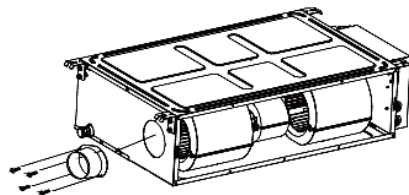

- (3) The air duct and round flange duct shall be concealed and kept warm well.

The fresh air is the air after filtration.

**NOTICE:**

- ①. The supply air duct, return air duct and fresh air duct shall have thermal insulation layer to prevent heat leakage and condensation. Stick the plastic nail to the air duct, then attach the heat preservation cotton with tinfoil and fix it with plastic nail cover, finally, seal the connection joint with tinfoil tape tightly; other materials with good thermal insulation effect can also be used.
- ②. Each supply air duct and return air duct shall be fixed on the floor prefabricated slab with iron support; the air duct joint shall be tightly sealed with glue to prevent leakage.
- ③. The design and construction of air duct shall meet related national engineering specifications and requirements.
- ④. The distance between the edge of return air duct and wall is suggested to be above 150mm, add filter screen for the return air inlet.
- ⑤. Noise reduction and shock absorption shall be considered in air duct design and construction. Moreover, the noise source shall avoid the crowd, e.g. the return air inlet shall never be designed at the top of the user (office and rest area).

3.3 Electrical Installation

3.3.1 Requirement and Notice on Electrical Installation

**WARNING:**

The electrical installation for the air conditioner should observe the following requirements:

- ①. The electrical installation must be conducted by professionals in compliance with local laws and regulations and the instructions in this manual. Never extend the power cord. The electric circuit must be equipped with a circuit breaker and air switch both with sufficient capacity.
- ②. The unit's operating power must be within the nominal range stated in the instruction manual. Use a specialized power circuit for the air conditioner.

Do not draw power from another power circuit.

- ③. The air conditioner circuit should be at least 1.5m away from any inflammable surface.
- ④. The external power cord, connection wire of indoor and outdoor units and the communication cords must be effectively fixed.
- ⑤. The external power cord, connection wire of indoor and outdoor units and the communication cords can't directly contact any hot objects. For example: they must not contact chimney pipes, warm gas pipes or other hot objects.
- ⑥. The external power cord, communication cords, and the connection wire of indoor and outdoor units must not be squeezed. Never pull, stretch or bend the wires.
- ⑦. The external power cord, communication cords and the connection wire of indoor and outdoor units must not collide with any metal beam or edge on the ceiling, or touch any metal burrs or sharp metal edge around.
- ⑧. Connect wires correspondingly by referring to the circuit diagram labeled on the unit or electric box. Screws must be tightened up. Slipped screws must be replaced by specialized flat-head screws.
- ⑨. Please use the power cables that are delivered along with the air conditioner. Do not change the power cables arbitrarily. Do not change the length and terminals of the power cables. If you want to change the power cables, please contact Gree's local service center.
- ⑩. Wiring terminals should be connected firmly to the terminal board. Loose connection is forbidden.
- ⑪. After the electrical installation is finished, please use wire clamps to secure the power cord, connection wire of indoor and outdoor units and the communication cords. Make sure the wires are not clamped too tight.
- ⑫. The wire gauge of power cord should be large enough. Damaged power cord or other wires must be replaced by specialized wires. Wiring work must be done according to national wiring rules and regulations.

3.3.2 Electrical Parameters

3.3.2.1 Wire Specifications and Fuse Capacity

Model	Power Supply	Fuse Capacity	Circuit Breaker Capacity	Min. Sectional Area of Power Cord
	V/Ph/Hz	A	A	mm ²
Indoor Unit	220-240V ~50Hz	3.15	6	1.0

Model	Power Supply	Circuit Breaker Capacity	Min. Sectional Area of Power Cord
	V/Ph/Hz	A	mm ²
GU50W/A1-K	220-240V ~50Hz	16	1.5
GU71W/A1-K	220-240V ~50Hz	20	2.5
GU85W/A1-K	220-240V ~50Hz	20	2.5
GU100W/A1-M	380-415V 3N~50Hz	16	1.5
GU125W/A1-M	380-415V 3N~50Hz	16	1.5
GU140W/A1-M	380-415V 3N~50Hz	16	1.5
GU160W/A1-M	380-415V 3N~50Hz	16	1.5



NOTICE:

- ①. Fuse is located on the main board.
- ②. Install a circuit breaker at every power terminal near the units (indoor and outdoor units) with at least 3mm contact gap. The units must be able to be plugged or unplugged.
- ③. Circuit breaker and power cord specifications listed in the above table are determined based on the maximum power input of the units.
- ④. Specifications of power cords listed in the above table are applicable in a working condition where ambient temperature is 40°C and multi-core copper cable (e.g. YJV copper cable, with insulated PE and PVC sheath) is protected by a conduit, and is resistant to 90°C in maximum (See IEC 60364-5-52). If working condition changes, please adjust the specifications according to national standards.

- ⑤. Specifications of circuit breaker are based on a working condition where the working temperature is 40°C. If working condition changes, please adjust the specifications according to national standards.
- ⑥. Adopt 2pc of 0.75mm² power cords to be the communication cords between indoor and outdoor units. The maximum length is 100m. Please select a proper length according to local conditions. Communication cords must not be twisted together. To be in compliance IOS5151, it is necessary to use 8 meters long wire.
- ⑦. Adopt 2pc of 0.75 mm² power cords to be the communication cords between wired control and indoor unit. The maximum length is 30m. Please select a proper length according to local conditions. Communication cords must not be twisted together. To be in compliance IOS5151, it is necessary to use 8 meters long wire.
- ⑧. The wire gauge of communication cord should not be less than 0.75 mm². It's recommended to use 0.75 mm² power cords as the communication cords.
- ⑨. Calculation of the maximum permissible system impedance:
 - a) The following evaluation procedure shall be applied if the equipment emissions cannot meet the technical requirements of IEC 61000-3-3 and therefore the equipment cannot be declared compliant by the manufacturer in accordance with 6.2.1. In such a case the equipment shall only be connected to a supply having a system impedance lower than Z_{ref} .
 - b) To be in compliance with EN 61000-3-11, impedance value of power-supply system connected to product must be less than or equal to the allowable maximum value of $|Z_{sys}|$ in the following sheet:

Models	Max $ Z_{sys} $ Unit:ohms
GU50W/A1-K	0.170
GU71W/A1-K	0.090
GU85W/A1-K	0.071
GU100W/A1-M	0.416
GU125W/A1-M	0.142
GU140W/A1-M	0.173
GU160W/A1-M	0.193

c) Before connecting the product to public power network, please consult your local power supply authority to ensure that the power network has met the above requirements. No requirement for the unlisted product's impedance value of power-supply system.

3.3.3 Connection of Power Cord and Communication Cord

(1) For solid wires (as shown below):

- 1) Use wire cutters to cut off the wire end and then peel away about 25mm of the insulation layer.
- 2) Use a screwdriver to unscrew the terminal screw on the terminal board.
- 3) Use nippers to bend the solid wire into a ring that fits the terminal screw.
- 4) Form a proper ring and then put it on the terminal board. Use a screwdriver to tighten up the terminal screw.

(2) For strand wires (as shown below):

- 1) Use wire cutters to cut off the wire end and then peel away about 10mm of the insulation layer.
- 2) Use a screwdriver to unscrew the terminal screw on the terminal board.
- 3) Use a round terminal fastener or clamp to fix the round terminal firmly on the peeled wire end.
- 4) Locate the round terminal conduit. Use a screwdriver to replace it and tighten up the terminal screw (as shown below).

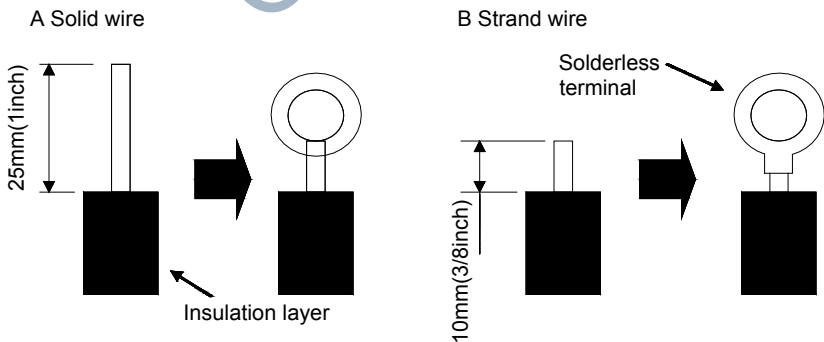

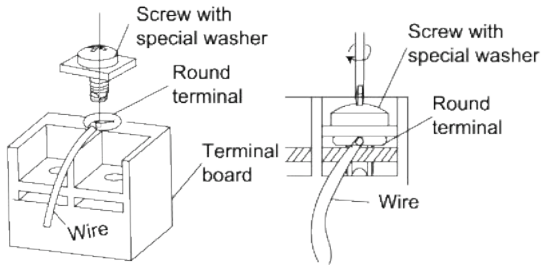

(3) How to connect the connection wire and power cord.

Lead the connection wire and power cord through the insulation tube. Then fix the wires with wire clamps (as shown in the next figure).

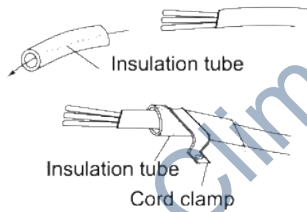

WARNING

- ①. Before working, please check whether the indoor and outdoor units are powered on.
- ②. Match the terminal numbers and wire colors with the colors indicated in the indoor unit.
- ③. Wrong wire connection may burn the electrical components.
- ④. Connect the wires firmly to the wiring box. Incomplete installation may lead to fire hazard.
- ⑤. Please use wire clamps to secure the external covers of connecting wires. (Insulators must be clamped securely; otherwise, electric leakage may occur.)
- ⑥. Ground wire should be connected.

(4) Electric wiring between the indoor and outdoor units.

GU50W/A1-K, GU71W/A1-K, GU85W/A1-K.

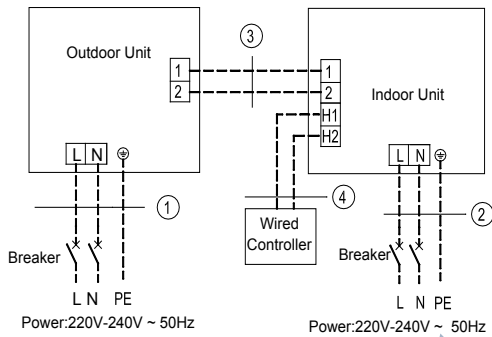

GU50P/A1-K; GU50PS/A1-K + GU50W/A1-K
①. Power cord 3×1.5mm ²
②. Power cord 3×1.0mm ²
③. Communication Cords 2×0.75mm ²
④. Communication Cords 2×0.75mm ²

GU71P/A1-K; GU71PS/A1-K + GU71W/A1-K GU85P/A1-K; GU85PS/A1-K + GU85W/A1-K
①. Power cord 3×2.5mm ²
②. Power cord 3×1.0mm ²
③. Communication Cords 2×0.75mm ²
④. Communication Cords 2×0.75mm ²

GU100W/A1-M, GU125W/A1-M, GU140W/A1-M, GU160W/A1-M.

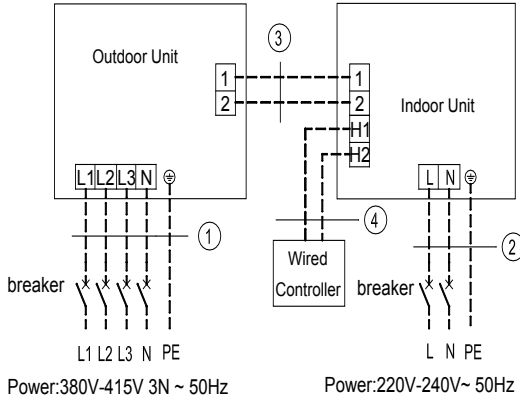

GU100PH/A1-K;GU100PHS/A1-K+GU100W/A1-M
GU125PH/A1-K;GU125PHS/A1-K+GU125W/A1-M
GU140PH/A1-K;GU140PHS/A1-K+GU140W/A1-M
GU160PH/A1-K;GU160PHS/A1-K+GU160W/A1-M
①. Power cord 5×1.5mm ²
②. Power cord 3×1.0mm ²
③. Communication Cords 2×0.75mm ²
④. Communication Cords 2×0.75mm ²

(5) Electrical wiring of indoor unit.

 WARNING
①. High and low voltage wires should be led through different rubber rings of the electric box cover.
②. Do not bundle up the connection wire and communication wire of wired control or lay them side by side, otherwise errors will occur.
③. High and low voltage wires should be secured separately. Secure the former ones with big clamps and the latter ones with small clamps.
④. Use screws to tighten up the connection wires and power cords of indoor and outdoor units on the terminal board. Wrong connection may lead to fire hazard.
⑤. If the connection wires of indoor unit (outdoor unit) and power cords are not correctly connected, the air conditioner may get damaged.
⑥. Ground the indoor and outdoor units through connecting the ground wire.
⑦. The units should comply with applicable local and national rules and regulations on power consumption.



- ⑧. When connecting the power cord, make sure the phase sequence of the power supply matches with the corresponding terminals, otherwise the compressor will get reversed and operate abnormally.

1) Indoor side

Take off the electric box cover from the sub-assembly of electric box. Then connect the wires. Connect the connection wires of indoor unit according to the corresponding marks.

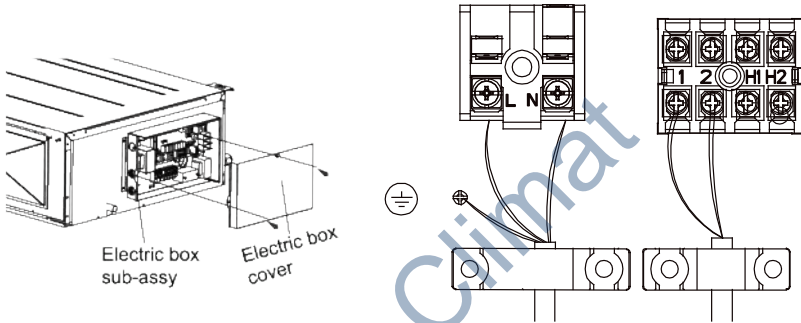

2) Outdoor side

Remove the big handle/front panel of the outdoor unit and insert one end of the communication cord and the power cord to the terminal board.

GU50W/A1-K, GU71W/A1-K, GU85W/A1-K

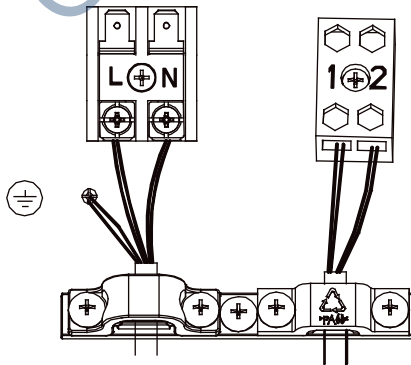

GU100W/A1-M, GU125W/A1-M, GU140W/A1-M, GU160W/A1-M

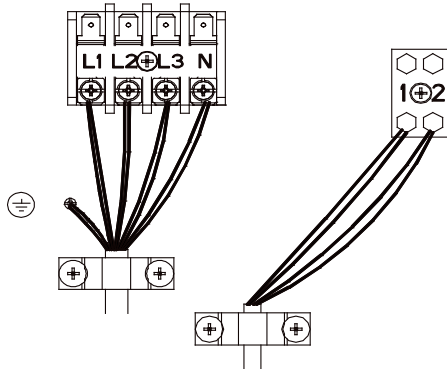

GU125W/A1-M, GU140W/A1-M, GU160W/A1-M

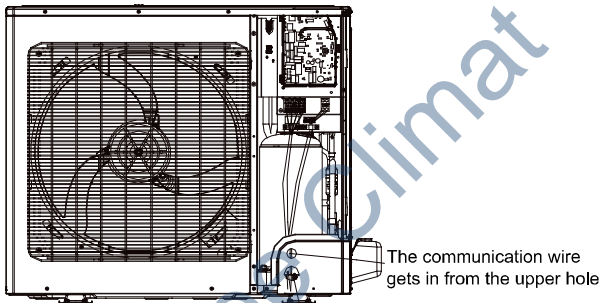

Power cord should be secured along with the right side plate and fixed to the hook with a wire clamp so as to avoid contacting the pipeline. The communication line between indoor and outdoor units should also be laid along with the right side plate but away from the power cord.

3.4 Check after Installation

Check Items after Installation

Check items	Possible events due to improper installation
Is the main body installed securely?	The unit may fall down, vibrate or produce noise.
Did you do water leakage test?	Cooling capacity may become unsatisfactory.
Is the unit well insulated from heat?	Condensate, water drops may occur.
Does water drainage go well?	Condensate, water drops may occur.

Check items	Possible events due to improper installation
Is the voltage consistent with that stated on the nameplate?	The unit may fail or its components may get burned.
Are the wires and pipes installed correctly?	The unit may fail or its components may get burned.
Has the unit been safely grounded?	Risk of electric leakage.
Do the specifications of wires comply with the requirement?	The unit may fail or its components may get burned.
Is there any obstacle blocking the air inlet and outlet of the indoor unit?	Cooling capacity may become unsatisfactory.
Have you recorded the length of refrigerant pipe and the refrigerant charging amount?	The refrigerant charging amount can't be controlled.

3.5 Test Running

Preparation before connecting the power.

- (1) Power must not be connected if the installation work is not completed.
- (2) Control circuit is correct and all the wires are firmly connected.
- (3) Cut-off valves of the gas pipe and liquid pipe are open.
- (4) The inside of the unit should be clean. Take irrelevant objects out if there is any.
- (5) After checking, re-install the front side plate.

Operation after connecting the power.

- (1) If all the above works are finished, power on the unit.
- (2) If the outside temperature is more than 30°C, heating mode can't be enabled.
- (3) Make sure the indoor and outdoor units can run normally.
- (4) If there's sound of liquid shock when the compressor is running, then stop the air conditioner immediately. Wait until the electric heating belt is heated enough, and then restart the air conditioner.
- (5) Feel the air flow of the indoor unit to see if it is normal.
- (6) Press the swing button or speed control button on remote control or wired control to see if the fan can run normally.



NOTICE:

- ①. If you use remote control to turn off the unit and then immediately turn the unit on again, compressor will need 3min to restart. Even if you press “ON/OFF” button on the remote control, it won’t be started up right away.
- ②. If there’s no display on the wired control, it’s probably because the connection wire between the indoor unit and wired control is not connected. Please check again.

4 Installation of Controller

Refer to the Installation Manual of the controller for more details.

5 Troubleshooting and Maintenance

5.1 Failures Not Caused by Faults of the AC

If your air-conditioning unit suffers from abnormal operation or failure, please first check the following points before repair:

Failure	Possible Reasons
The unit cannot be started.	1) The power supply is not connected. 2) Electrical leakage of air-conditioning unit causes tripping of the leakage switch. 3) The operating keys are locked. 4) The control loop has failure.
The unit operates for a while and then stops.	1) There is obstacle in front of the condenser. 2) The control loop is abnormal.
Poor cooling effect.	1) The air filter is dirty or blocked. 2) There is heat source or too many people inside the room. 3) The door or window is open. 4) There is obstacle at the air intake or outlet. 5) The set temperature is too high. 6) There is refrigerant leakage. 7) The performance of room temperature sensor becomes worse.



NOTICE:

Check the above items and adopt the corresponding corrective measures. If the air conditioner continues to function poorly, please stop the air conditioner immediately and contact Gree’s authorized local service center. Ask our

5.2 Error Code



WARNING

- ①. If abnormal things (for example, awful smell) occur, please stop the unit immediately and disconnect power. Then contact Gree's authorized service center. If the unit continues to run in abnormal situations, it may get damaged and cause electric shock or fire hazard.
- ②. Do not repair the air conditioner by yourself. Improper maintenance will cause electric shock or fire hazard. Please contact Gree's authorized service center and send for professional service staff to repair.

If the display panel or wired control displays an error code, please refer to the error code meaning stated in the following table.

Number	Error code	Error
1	E1	Compressor high pressure protection
2	E2	Indoor anti-freeze protection
3	E3	Compressor low pressure protection, refrigerant lack protection and refrigerant collecting mode
4	E4	Compressor air discharge high-temperature protection
5	E6	Communication error
6	E8	Indoor fan error
7	E9	Water-full protection
8	F0	Indoor ambient temperature sensor error
9	F1	Evaporator temperature sensor error
10	F2	Condenser temperature sensor error
11	F3	Outdoor ambient temperature sensor error
12	F4	Discharge temperature sensor error
13	F5	Wired control temperature sensor error
14	C5	IDU jumper cap error
15	EE	IDU or ODU memory chip error
16	PF	Electric box sensor error
17	H3	Compressor overload protection
18	H4	Overload
19	C4	ODU jumper cap error
20	EL	Emergency Stop(Fire Alarm)



NOTICE:

When the unit is connected with the wired controller, the error code will be simultaneously shown on it.

5.3 Unit Maintenance

5.3.1 Filter Cleaning

Increase the frequency of cleaning if the unit is installed in a room where the air is extremely contaminated (As a yardstick for yourself, consider cleaning the filter once a half year).

If dirt becomes impossible to clean, change the air filter (Air filter for exchange is optional).

- (1) Removing the air filter from the duct.
- (2) Cleaning the air filter.

Remove dust from the air filter using a vacuum cleaner and gently rinse them in cool water. Do not use detergent or hot water to avoid filter shrinking or deformation. After cleaning dry them in the shade.

Press the return air filter downward against the guide groove sponge. There are two or three return air inlet filters.

- (3) Replacing the air filter Reinstall the filter as before.

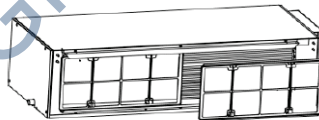

5.3.2 Heat Exchanger of Outdoor Unit

Conduct cleaning for the heat exchanger of outdoor unit periodically, clean it once at least in every two months. Clean the dust and sundries on the surface of the heat exchanger with dust collector and nylon brush, if there's compressed air source; use the compressed air to blow the dust on the surface of the heat exchanger. Don't use tap water for cleaning.

5.3.3 Drainage Pipe

Periodically check if the drainage pipe is blocked to smooth the condensate water.

5.3.4 Notices at the Beginning of the Using Season

- (1) Check if there is blockage at the inlet or outlet vent of air conditioner.
- (2) Check if the earth wire has been attached reliably by the skilled serviceman.
- (3) Check if the exhausted batteries of the wireless controller have been replaced.
- (4) Check if the air filter had been installed well by professional.

Keep the power switch “On” 8 hours before the startup of the unit which has not been used for a long period.

5.3.5 Maintenance at the end of the Using Season

- (1) Cut off the main power of air conditioner.
- (2) Clean the air filters and other parts by the skilled serviceman.
- (3) Leave the fan running for 2-3 hours to dry the inside of the unit.

5.3.6 Components Replacement

Components are available in Gree agency or Gree distributors nearby.

5.4 After-Sales Services

Any quality or other issues encountered in the purchased air conditioner, please contact the local Gree after-sales service department.



ОФІЦІЙНИЙ ДИЛЕР GREE В УКРАЇНІ

Gree Climat



GREE ELECTRIC APPLIANCES, INC. OF ZHUHAI

Add: West Jinji Rd, Qianshan, Zhuhai, Guangdong, China, 519070

Tel: (+86-756) 8522218

Fax: (+86-756) 8669426

E-mail: gree@gree.com.cn www.gree.com



600005060960